

# Solid State Devices Used in Combining Coding and Phase Modulation

**Ziad Saeed Mohammed**  
[dr.ziadsaeed@ntu.edu.iq](mailto:dr.ziadsaeed@ntu.edu.iq)

Computer Technology Departement, Engineering Technical Collage/ Mosul, Northern Technical University, Mosul, Iraq

Received: December 31<sup>th</sup>, 2022    Received in revised form: June 26<sup>th</sup>, 2023    Accepted: July 29<sup>th</sup>, 2023

## ABSTRACT

The current project dealing with communication system through adoption of the particular digital modulation by using solid state components as a semiconductor device, using the phase- Shift keying (PSK) signal that has been adopted by combined coding with phase modulation. To increase the coded signal's minimum free distance as an objective of the work, by using the coding (Channel Coding) is a preferred approach to enhance the signal to noise ratio (SNR) performance of the transmission of digital signals, and for completing of the project task, a simulation methodology has been implemented the required investigation. The results reveal that the minimum free distance is equal the root of 2, i.e  $D=1.414$ , the output encoder with rate of  $2/3$  i.e 8-PSK signal and the change of phase of the signal point does affect the minimum free distance of the coded signal.

## Keywords:

Convolution code; Digital communication; Multiphase signal waveform; Solid state devices.

This is an open access article under the CC BY 4.0 license (<http://creativecommons.org/licenses/by/4.0/>).

<https://rengj.mosuljournals.com>

Email: [alrafidain\\_engjournal1@uomosul.edu.iq](mailto:alrafidain_engjournal1@uomosul.edu.iq)

## 1. INTRODUCTION

A carrier signal is modulated by the digital stream representing the information. Digital modulating is, referral in some application over the analog modulation since:

1. Ease of multiplexing.
2. operability of low signal-to-noise interference ratios
3. Ease of encryption.
4. Signal regeneration.
5. Use of modern technology
6. Integration of transmission and switching.

Band pass modulation is often utilized for wireless communications across vast distances. Carrier modulation is another name for band pass modulation. Bandpass modulation techniques encode information as the amplitude, frequency, phase, or phase and amplitude of a sinusoidal carrier. These bandpass modulation schemes are known by their acronyms ASK (amplitude shift keying), FSK (frequency shift keying), PSK (phase shift keying), and QAM (quaternary amplitude modulation), where keying or modulation is used to indicate that a carrier signal is modified in some manner.) [1]. The characteristics of the carrier signal, having high-frequency sinusoidal pulse, are

modified by using a series of digital symbols such a sinusoidal of duration  $T$  is referred to it. A sinusoidal signal has three known properties: amplitude, frequency, and phase. Thus, the three fundamental modulation techniques in passband modulation are amplitude modulation, frequency modulation, and phase modulation. The three fundamental types of digital modulation [2], are:

1. Amplitude-Shift keying (ASK)
2. Frequency-Shift keying (FSK)
3. phase - Shift keying (PSK)

The use of coding (Channel Coding) is a preferred approach to enhance the signal to noise ratio (SNR) performed of the transmission of digital signals.

## 2. MULTIPHASE SIGNALING WAVE FORMS

For a fixed information rate ( $R$ ) channel bandwidth required to transmitted the signal is increase as the number of waveforms is increased. In contrast the signaling waveform discussed in this section namely, multiphase, multi amplitude, were combined amplitude and phase signals, have the characteristics of the channel bandwidth requirement at afix rate actually decrease with an increase in  $M$ . The penalty of using such bandwidth efficient waveforms

increase in the SNR necessary to reach a certain level of performance, i.e, the -efficient waveforms are appropriate for channels have a large SNR. A collection of M-array phase (multiphase) signaling waveforms is often representing as:

$$S_m(t) = Re \left\{ U(t) \exp j(2\pi f_c t) + \frac{2\pi}{M}(m - 1) + \lambda \right\} \quad (1)$$

m=1,2,.....M 0 < t < T

Where ( $\lambda$ ) is an initial phase. If u(t) is a rectangular pulse an amplitude A,  $S_m(t)$  may be expressed as:

$$S_m(t) = A \cos \left\{ 2\pi f_c t + \frac{2\pi}{M}(m - 1) + \lambda \right\} \quad (2)$$

m=1,2,.....M 0 < t < T

and the signaling technique is called phase-shift keying (PSK). The M signaling waveforms have equal energy. By expanding the cosine function in eqns. (1 & 2), the signaling waveforms may be expressed as:

$$S_m(t) = A_{cm} \cos 2\pi f_c t - A_{sm} \sin 2\pi f_c t \quad (3)$$

where by definition:

$$A_{cm} = A \cos \left[ \frac{2\pi}{M}(m - 1) + \lambda \right] \quad (4)$$

$$A_{sm} = A \sin \left[ \frac{2\pi}{M}(m - 1) + \lambda \right] \quad (5)$$

The signal given by eqns. (1) to (5)[3] is viewed as two quadrature carriers with amplitudes  $A_{cm}$  and  $A_{sm}$  which depends on the transmitted phase in each signaling interval. Applications for multi-phase waveforms are everywhere – in Power-related applications, I/Q modulation, Automobile applications, Components, etc. [4]. For illustrative purposes we show the phase of the carrier of the signal as points in a plane at a distance A from the origin and the separated in angle by  $2\pi/m$ . For example, Fig.1[5] illustrates signal constellation for four-phase and eight phase PSK. The effect of initial phase is to rotate signal constellation as shown in Fig. 1. In particular we note that when and  $M= 4$  we have  $A_{cm} = \pm A/\sqrt{2}$ . Hence (3) may be expressed as:

$$S(t) = \pm \frac{A}{\sqrt{2}} \cos 2\pi f_c t \pm \frac{A}{\sqrt{2}} \sin 2\pi f_c t \quad (6)$$

In other words, the four-phase PSK signal constellation in Fig. 1 and described by eqn. (6) may be viewed as two binary PSK signals impressed on the quadrature carrier  $\cos(2\pi f_c t)$  and  $\sin(2\pi f_c t)$ . Viewed in this manner, the four-phase PSK signal is generated by the modulator shown in block diagram form in Fig. 2[6].

There are several methods to map or allocate K information bits to the  $M = 2^k$  potential phases. The preferred assignment, as shown in fig.,

is one where the distance between neighboring phases is one binary digit (1). Gray encoding is the name of this mapping. It is crucial to the demodulation of the signal because the noise mistakes that are most likely to occur include the incorrect choice of a phase that is close to the phase of the transmitted signal. In this scenario, the K-bit sequence only experiences a signal bit mistake. The general form of the optimum demodulator for detecting one of M signals in an AWGN. channels, as derived previously is one that computes the decision variables.

$$U_m = Re \left\{ e^{j\theta} \int_0^T r(t) u(t) \exp[-j + \left(\frac{2\pi}{M}(m - 1) + \lambda\right)] dt \right\} \quad (7)$$

and select the signal corresponding to the largest decision variable. We observe that the exponential factor under the integral in eqns. (1) to (7) is independent of the variable of integration, and, it can be factored out. As a result, the optimum demodulator can be implemented as signal matched filter or cross correlator which computes the vector, in signal processing, cross-correlation is a measure of similarity of two waveforms as function of a time-lag applied to one of them.

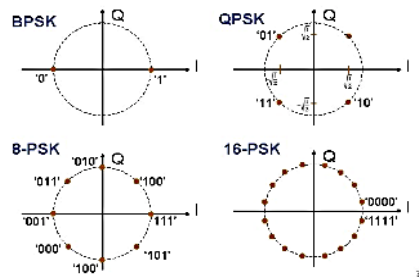

$$V = e^{j\theta} \int_0^T r(t)u(t)dt \quad (8)$$

Fig. 1 Signal constellation for four-phase and eight phase PSK [3]

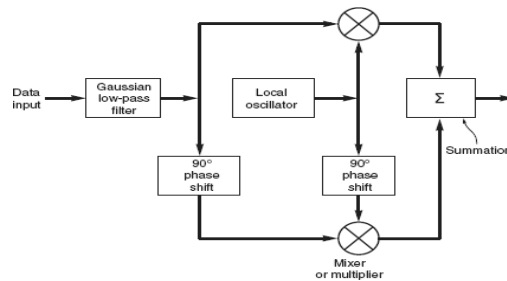

Fig. 2 Block diagram of modulator for four phase PSK [6].

Fig.3 shows the block diagram of demodulator for recovering the noise corrupted signal components  $A_{cm}$  and  $A_{sm}$ , from which the

vector  $V$  is found formed. The projection of  $V$  into the unit vector  $V_m = \frac{1}{\sqrt{2}}(a_m - jm_b)$  is simply accomplished by the formation of the product.

$U_m = X_{acm} + Y_{asm}$ ,  $m = 1, 2, \dots, M$ . Equivalently the vector  $V$  can be followed by a phase detector which computes the phase of  $v$ , and denoted by  $\theta$ , and selects from the set  $\{S_m(t)\}$  that signal having a phase closest to  $\theta$ .

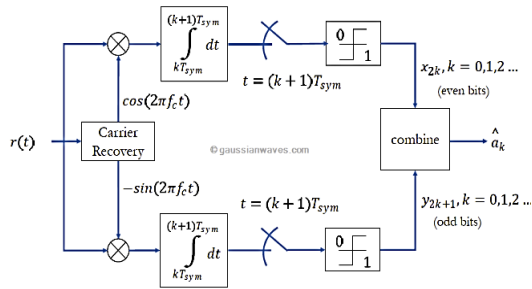

Fig. 3 Block diagram of demodulator for PSK signals [7]

**2.1 Channel coding:**

Block codes and convolutional (or recurrent) codes, two significant forms of coding, will be covered in this section. It will be assumed that the data arriving from the data source for message is in binary format (sequence of binary digits). Block codes encrypt a block of  $K$  data digits using an  $n$ -digit code word. ( $n > K$ ).

**2.1.1 The convolutional codes:**

The information sequence to be sent is passed through a linear finite-state shift register to create convolutional code. Fig.4 illustrates how the shift register typically comprises of  $n$  linear algebra function generators and  $L$  ( $K$ -bit) stages (4). Convolutional codes are error-correcting codes based on shift registers for polynomial encoding and decoding [8]. The encoder's input data, which is supposed to be binary, is moved  $K$

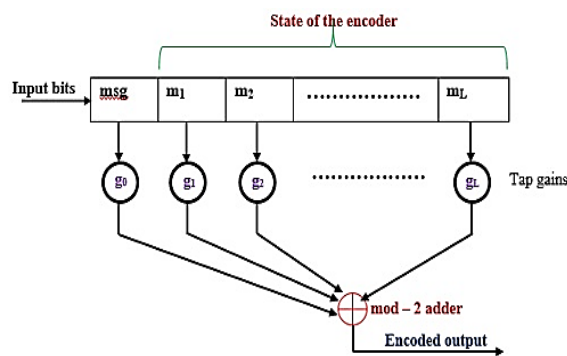

Fig. 4 convolutional encoder bits at a time into and along the shift register. For each  $K$ -bit input sequence, there are  $n$  bits of output.

In line with the definition of the code rate for a block code, the code rate is thus defined as  $R_c = K/n$ . The convolutional code's constraint length is denoted by the parameter  $L$ . The constraint length of the code is often specified in bits rather than  $K$ -bit bytes. Since  $K = Lk$ , the shift register may be referred to as a  $K$ -stage shift register. In general,  $K$  may not always be a multiple of  $K$ . Giving the generator matrix for a convolutional code, like we did for block CEDES, is one way to describe it.

By adding two or more mod-2 adders to the shift registers, an output rate larger than the message bit may be produced, supplying the additional bits needed for error control [9]. Since the length of the input sequence is semi-infinite, the generator matrix for a convolutional code is often semi-infinite. We will use a functionally comparable notation instead of describing the generator matrix in which we supply a collection of  $n$  vectors, one vector for each of the  $n$  modulo-2 adders. Each vector contains the relationship between the encoder and that modulo-2 adder and has  $LK$  dimensions. A 0" in a particular location indicates that there is no connection between that stage and the modulo-2 adder, and a 1" in the vector's  $i$ th place denotes that the corresponding stage in the shift register is linked to the modulo-2 adder.

From top to bottom, we number the function generators that produce each three-bit output sequence as 1, 2, and 3, and we do the same for each related function generator.

Since there is no need for a modulo-2 adder since just the first stage is linked to the first function generator, the generator is:  $g_1 = (100)$  Stages 1 and 3 are linked to the second generator. Thus,  $g_2 = (101)$  Lastly,  $g_3 = (111)$ .

**2.1.2 Trellis coded modulation:**

Trellis-Coded Modulation (TCM), a combined coding and modulation approach for digital transmission across band-restricted channels, has developed during the last ten years. Its key selling point is that it enables large coding gains over traditional uncoded multilevel modulation while maintaining high bandwidth economy. TCM study and practice took off, and as a result, the theory behind and practical applications of TCM approaches are now well understood.

The noisy signals in the receiver are decoded by maximum soft-decision - probability series decoder. A TCM can advance the sturdiness of digital transmission against additive noise by 3dB by Simple four states, related to conventional uncoded inflection. The gain may be increased to

6 dB or higher with additional composite TCM schemes; these gains are measured without B. As required by conventional error correction systems, W expansion are decreasing the active information rate. The original block of data bits is retrieved by the receiver using estimations of the sent symbol and the active antenna index. In this study, TCM divides the complete set of transmit antennas into sub-sets to optimize the distance between antennas in each sub-set. [10].

More than 30 years ago, Shannon's information theory predicted the development of coded modulation schemes with these features. Today's signal processing technology and efficient TCM approaches have made it possible to get these gains in reality. Signal wave patterns that represent information sequences are most resistant to noise-induced detection mistakes if they are substantially distinct from one another. He can get some information when someone else pick one sequence and "communicate" it to him [11]. This mathematical need translates into the need for a long signal sequence in Euclidean signal space. Utilizing signal-set expansion to offer redundancy for coding and combining design and signal-mapping functions to optimize the (free distance) and (minimum Euclidean distance) between the signal sequences was the fundamentally novel notion of TCM that produced the aforementioned advantages.

**2.2 Coding in classical corrected errors:**

A classical digitized communications system, the function of error modulated& correction coding is disjointed. The unit of information is bit in modern information systems, a bit takes one of two values: 0 or 1[12]. In conservative multi-level (A.M /or P.M) mod. system, through each interval the modulators charts binary codes bits into one of Modules = 2m probable transmitted band, and demo. recover the m bits by building a self-determining M-array nearest neighbor judgment for each signal received. Fig.5 displays constellations with sophisticated or actual value, hence-forth called signal sets-which are usually working for 1or 2 D-M-array linear modulation, 2- dimensional carrier requires a bandwidth (1/T) Hertz about transporter freq. to transmit signals rate of 1 / T signals/sec. (baud) without inter symbol interference. Hence 2-D 2m -array system have achieved a spectral effectiveness of about bit/sec/Hertz [12]. The same spectral efficiency were achieved using one-dimensional base band modulation using a 2m-array. Traditional error-correcting encoders and decoders work with binary, or more broadly (Q-Array), code symbols sent via discrete channels.

Every k information symbols get an additional n-k redundant check symbol when the code or rate is k/n 1.

Considering that the decoder only gets distinct coding symbols. Hamming distance is the ideal distance for decoding and, hence, for creating codes. In the case of convolutional codes, a mini hamming distance, also known as a free hamming distance, certifies that the translator may be repaired for at least ((d<sub>hmin</sub> -1)/2) code symbol mistakes. The specification of the variation scheme is constrained if there are poor signal-to-noise ratios or non-stationary signals.

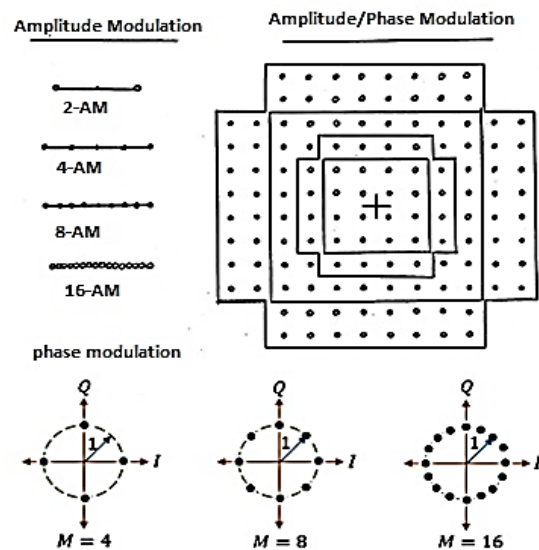

Fig. 5 Signals sets 1-D, A.M & 2-D, /P.M

**2.3 Minimum free distance:**

The minimal distance between various code words as specified by the code of free distance is (1,1)[13].

$$d^2(x_0, x_1) = \|x_0 - x_1\|^2 \quad (9)$$

i.e. the min. free distance

$$d_{free} = \min * (d(x_i, x_j)) \quad (10)$$

A lower constraint on the likelihood of an error-event is thus provided by:

$$p_s \geq Q \left( \frac{d_{free}}{2\pi} \right) \quad (11)$$

And this bound is approached asymptotically at high signal -to-noise ratio. The asymptotic coding gain G dB, achieved by this system over the corresponding uncoded system is given by:

$$G = 20 \log_{10} \left( \frac{d_{free}}{d_{uncoded}^2} \right) \quad (12)$$

The goal of code selection is, of course, to maximize asymptotic coding gain, where  $D_{uncoded}$  is the least Euclidean distance between distinct sequences of the uncoded reference system with the same average or peak power.

**2.3.1 System model for digital communication:**

The block diagram in Fig. 6 provides an overview of the fundamentals of digital communication systems that use wave channel coding. It is believed that the encoder's input will consist of a series of binary digits (bits) happening at a rate of  $R$  bit/s. Convolutional coding is the encoder utilized in the system model. The sequence of binary digits (bits) is insert to the serial to parallel converter which convert the sequence from series to parallel sequence to get two output. And this output is fed to a convolutional encoder which gives three output digits at a time, and also is input to the modulator to get different o/p which represent 8-PSK. The PSK signal is complex and lie on a circle. The angle between any two adjacent point a is  $45^\circ$ . The 8-PSK is represented as a real and imaginary parts. 8-PSK signal constellations is shown in Fig. (7).

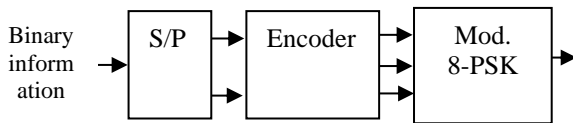

Fig. 6 Block diagram of model system

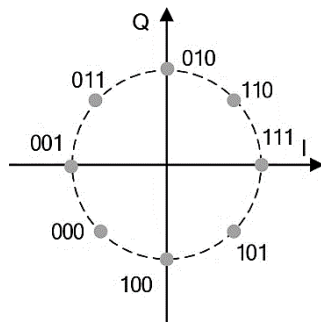

Fig.7 8-PSK signal constellations

**2.3.2 Encoder circuit:**

A rotationally invariant eight-state coder with a 3.0 dB maximum asymptotic coding increase is used the circuit used shown in Fig. 8 From this circuit which contain three shift register (T) each register given a certain delay and contain three EX-OR gates and contain NOR and AND gate[14].From this circuit in Fig.8 is  $V_1$  and  $V_2$  take different state,  $(t_1, t_2, t_3)$  and have a output at each

state  $V_1, V_2, V_3$ , the next state for each is  $(t_1^*, t_2^*, t_3^*)$ . The truth table of the encoder is shown in  $(00, 01, 10, 11)$  at each state we have present state.

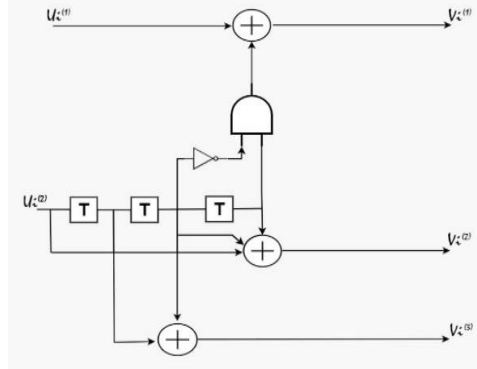

Fig.8 Eight-state rotationally invariant coder for 8-PSK signals.

Table 1: Encoder Truth Table.

INPUT		PRESENT STATE			OUTPUT			NEXT STATE		
$U_1$	$U_2$	$t_1$	$t_2$	$t_3$	$V_1$	$V_2$	$V_3$	$t_1^*$	$t_2^*$	$t_3^*$
0	0	0	0	0	0	0	0	0	0	0
0	0	0	0	1	1	1	0	0	0	0
0	0	0	1	0	0	1	1	0	0	1
0	0	0	1	1	0	0	1	0	0	1
0	0	1	0	0	0	0	1	0	1	0
0	0	1	0	1	1	1	1	0	1	0
0	0	1	1	0	0	1	0	0	1	1
0	0	1	1	1	0	0	0	0	1	1
0	1	0	0	0	0	1	0	1	0	0
0	1	0	0	1	1	0	0	1	0	0
0	1	0	1	0	0	0	1	1	0	1
0	1	0	1	1	0	1	1	1	0	1
0	1	1	0	0	0	1	1	1	1	0
0	1	1	0	1	1	0	1	1	1	0
0	1	1	1	0	0	0	0	1	1	1
0	1	1	1	1	0	1	0	1	1	1
1	0	0	0	0	1	0	0	0	0	0
1	0	0	0	1	0	1	0	0	0	0
1	0	0	1	0	1	1	1	0	0	1
1	0	0	1	1	1	0	1	0	0	1
1	0	1	0	0	1	0	1	0	1	0
1	0	1	0	1	0	1	1	0	1	0
1	0	1	1	0	1	1	0	0	1	1
1	0	1	1	1	1	0	0	0	1	1
1	1	0	0	0	1	1	0	1	0	0
1	1	0	0	1	0	0	0	1	0	0
1	1	0	1	0	1	0	1	1	0	1
1	1	0	1	1	1	1	1	1	0	1
1	1	1	0	0	1	1	1	1	1	0
1	1	1	0	1	0	0	1	1	1	0
1	1	1	1	0	1	0	0	1	1	1
1	1	1	1	1	1	1	0	1	1	1

**3. CHANGE OF PHASES & MINIMUM FREE DISTANCE**

In this section we explain the four cases for changing the phases and effect on the min. free



distance. The smallest possible free distance is calculate the by difference of the real part from the real part reference of all cases of the fourth change of 8-PSK as shown in equation:

$$DR = R_{Er} - R_{ref} \quad (13)$$

Where; DR: is the real part of minimum free distance,  $R_{ref}$ :is the real part reference, and  $R_{Er}$ : is the real part of stage.

The imaginary part can be calculated by the difference between the imaginary part value of the fourth change of phase 8-PSK.

$$DI = IM_i - IM_{ref} \quad (14)$$

Where DI: is the imaginary part of minimum free distance,  $IM_i$ :is the imaginary part of middle input,  $IM_{ref}$ : is the imaginary reference.

In the first stage the reference sequence data is ten pair bits all of this bits are zero. The input sequence it must be difference from the reference data at least of one bit this differ bit in middle of input sequence, the first of two pair bits it must he remain zero and the final of five pair bits is also remain zero, the change of bits in the other of third pair bits, this case conclude all the fourth change of the phases. In the second stage change the reference sequence data is ten pair bits but all of bits is One. The input sequence must be difference from the reference data at least of one bit, this differ bits, in middle of input sequence.

The first of two pair bits it must be remain one and the final of five pair bits is also remain one, the change of the bits in the other of third pair bits, this case conclude all the fourth change of phases of 8-PSK.By using this relationship above to obtained the minimum free distance.

$$DD = DR^2 + DI^2 \quad (15)$$

Where DD:is the minimum free distance.

The Total of DD of zo bits input data sequence is calculated as shown below:

$$DD = \sum_1^{10} ((R_{Er} - R_{ref})^2 + (IM_i - IM_{ref})^2) \quad (16)$$

The relation above is applied to the Fourth cases change of phase of 8- PSK.

Fig.9 shows the four cases of changing the phases. In first case the binary output digits arranged as shown in Fig. 9-a and the phase difference between the adjacent points is 450 and also calculate the min. free distance. In second case we fixed the output digits that lie on X & Y axis and rotate the reminder output which lie on the other axis by one angle 67.50 anticlockwise,

and calculate the min. free distance, this is shown in Fig. 9-b. In third case we fixed o/p digits lie on X & Y axis and I rotate the reminder output digits which lie on the other axis in case(I) by an angle 22.50 in clockwise direction and the

we calculate the min. free distance this shown in Fig.9-c. In fourth case we make an 22.5° between two adjacent output such as between 111, 000, 001, 010, 011,100, 101,110 as shown in Fig. 9-d.

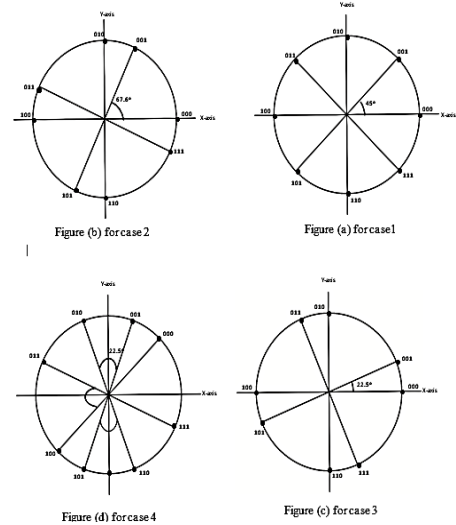

Fig. 9 Different Cases Change in Phase

4. RESULTS AND DICUSSION

Through the foregoing procedures, calculations, and operations of changing the phase to the signal using a proposed method, the results shown in Table 2 were obtained. the phase in degree and minimum free distance and the sequence which gives this (min. free distance) with (Ref. sequence all zero).When the phase angle is 45, 67.5,22,5,and 11.25 degree the minimum .free distance is 4 respectively for all different sequence.

Table.2: phases and min. free distance with sequences.

Phase	Min.free distance	Sequence
45°	4	00 00 10 00 00 00 00 00 00 00 00
67.5°	4	00 00 10 00 00 00 00 00 00 00 00
22.5°	4	00 00 10 00 00 00 00 00 00 00 00
11.25°	4	00 00 10 00 00 00 00 00 00 00 00

5. CONCLUSIONS

Through this project it can be conclude that: The basic idea of coding is to add to the message “digits” group of check digits, to transmitted the check digits and top provide the receiver enough information to either identify or rectify channel error after sending the complete block of digits via the channel.The concept of phase transition is used in 8-PSK it is also can be used in the Quadrature

Amplitude Modulation (QAM), with TCM. Trellis-coded modulation (TCM) have involved over the port decide as the mutual coding and phase-modulation method discrete communication concluded band-limited channel. The trellis coded mod. was calculated in an experimental mode, similar to the other simple TCM systems. The uncoded signal is bit / t is 4-PSK signal is fed to encoded. The minimum free distance is equal the root of 2 . i.e.  $D = 1.414$ . The output encoder with rate of 2/3 i.e. 8-PSK signal. The minimum free distance of trellis coding of 8-PSK is equal to 2 as shown in Fig. 10.

The coding gain can be calculated by the formula:

$$G = 20 \log \frac{D_{\text{coded}}}{D_{\text{uncoded}}} \quad (17)$$

Where  $D$ : is the minimum the free distance for uncoded and coded signal respectively.

Hence the coding gain is:

$$G = 20 \log \frac{2}{1.414} = 3 \text{ dB} \quad (18)$$

As a conclusion it seems that the change of phase of the signal point does affect the minimum free distance of the coded signal.

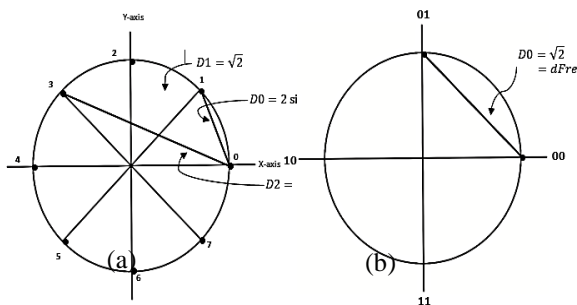

Fig. (10), (a) 8-PSK (b) 4-PSK

## REFERENCES

- [1] D. Silage "Digital Communication Systems Using SystemVue" ch3. Charles River Media, Inc. 2006.
- [2] F. Xiong, "Digital Modulation Techniques" ARTECH HOUSE, INC, 2006.
- [3] S. Haykin, "Communications Systems". Wiley, 2000.

- [4] C. Govindarajuy and K. Baskaran, "Analysis and Implementation of Multiphase Multilevel Hybrid Single Carrier Sinusoidal Modulation", Journal of Power Electronics, Vol. 10, No. 4, July 2010.
- [5] D. Tse and P. Viswanath, "Fundamentals of Wireless Communication", Cambridge University Press, New York, NY, USA 2005..
- [6] I. Poole, Adrio, "Modulation basics, part 2: Phase modulation Communications Ltd", Staines, UK 06.08.2008
- [7] Mathuranathan, "QPSK modulation & demodulation (Matlab and Python)", Independently published, October 19, 2010.
- [8] P. Latawa, and N. Aydin "Applications of Convolutional Codes to DNA Codes and Error-Correction", Liberal Arts and Science Academy (LASA), Austin, TX, USA. 2021.
- [9] Vijay K. Garg, "Speech Coding and Channel Coding", Wireless Communications & Networking, 2007.
- [10] R. Mesleh, M. Di Renzo, H. Haas, P. M. Grant, "Trellis Coded Spatial Modulation", IEEE Transactions on Wireless Communications, Volume: 9, Issue: 7, July 2010.
- [11] R. Xiaofeng Chen, "A Brief Introduction on Shannon's Information Theory", arXiv:1612.09316v1 [cs.IT] 20 Dec 2016.
- [12] H. Chang, "An Introduction to Error-Correcting Codes: From Classical to Quantum" Carnegie Mellon University, 2018.
- [13] B. P. Lathi, Zhi Ding, "Modern digital and analog communication systems" Oxford University Press, Inc, 2009.
- [14] K. K. Mohammad, F. H. Taha, "Fabrication and Study of Memory Cell Switch Properties Based on Cu<sub>2</sub>S Compound", Al-Rafidain Engineering Journal (AREJ), vol. 20, Issue 6, December 2012.

## أجهزة الحالة الصلبة المستخدمة في الجمع بين الترميز والتضمين الطوري

زياد سعيد محمد

[dr.ziadsaeed@ntu.edu.iq](mailto:dr.ziadsaeed@ntu.edu.iq)

قسم هندسة تقنيات الحاسوب، الكلية التقنية الهندسية، الجامعة التقنية الشمالية، موصل، العراق

تاريخ الاستلام: 31 ديسمبر 2022      استلم بصيغته المنقحة: 26 يونيو 2023      تاريخ القبول: 29 يوليو 2023

### الملخص:

تعامل المشروع الحالي مع نظام الاتصال من خلال اعتماد التعديل الرقمي المعين باستخدام مكونات الحالة الصلبة كجهاز أشباه الموصلات، باستخدام إشارة المرحلة-التحول (PSK) التي تم اعتمادها عن طريق التشفير المشترك مع تعديل الطور. لزيادة الحد الأدنى للمسافة الحرة للإشارة المشفرة كهدف للعمل، بعد استخدام التشفير (تشفير القناة) نهجاً مفضلاً لتحسين أداء نسبة الإشارة إلى الضوضاء (SNR) لإرسال الإشارات الرقمية، ولاستكمال مهمة مشروع البحث، تم تنفيذ منهجية محاكاة التحقق المطلوب. كشفت النتائج أن الحد الأدنى للمسافة الحرة يساوي جذر 2، أي  $D = 1.414$ ، ومشفّر الإخراج بمعدل 3/2 أي إشارة PSK-8 وتغيير طور نقطة الإشارة يؤثر على المسافة الحرة الدنيا للإشارة المشفرة.

### الكلمات الداله:

كود الالتفاف، الاتصال الرقمي، شكل موجة الإشارة متعدد الأطوار، أجهزة الحالة الصلبة.