

Factors affecting the static operation of Erbium Doped Fiber Amplifier(EDFA)

T.A.AL-Jumailly

F.Y.AL-Abayagee

Tarq-al-jomely@yahoo.com

Furat_al2003@yahoo.com

Computer Eng. Dept. College of Eng. University of Mosul, Iraq

Abstract

Doping a part of the optical fiber core by (Er^{3+}) ions with the availability of external pumping power (pump laser), will lead to the formation of erbium-doped fiber amplifier (EDFA). The performance of this optical amplifier depends on the parameters in this article which form this optical amplifier (the power and the wavelength of the pumping laser, the power and wavelength of the input signal, amplifier length, ion concentration). The effects of these quantities on the action and performance of erbium amplifiers such as amplifier gain, gain saturation, noise figure and out power of the amplifier are investigated.

Keywords: *Erbium Doped Fiber Amplifier(EDFA), Single mode, Population inversion.*

تأثير العوامل الساكنة على عمل المكبر الليفي المطعم بأيونات الاربيوم

فرات يونس عبد الرزاق

د. طارق عبدالله الجميلي

قسم هندسة الحاسبات- كلية الهندسة- جامعة الموصل

الخلاصة :

أن تطعيم جزء من لب الليف الضوئي بايونات الاربيوم مع توفر قدرة ضخ خارجية يتكون لدينا مكبر ضوئي مطعم بايونات الاربيوم. أن عمل وأداء هذا المكبر الضوئي يعتمد على قيم المقادير التي تشكل هذا المكبر الضوئي (القدرة والطول الموجي للمضخ الليزري الضوئي، القدرة والطول الموجي للإشارة الضوئية الساقطة المراد تكبيرها، طول المكبر، كمية التطعيم). حيث تم دراسة تأثير هذه المقادير على عمل وأداء مكبرات الاربيوم من ناحية كسب المكبر واشباع الكسب ورمز الضوضاء وقدرة الإخراج للمكبر.

1-Introduction

Received 10 August 2005

Accepted 10 July 2006

The practical use of optical amplifiers was an important milestone in the history of optical fiber communication systems. In contrast to the widely used opto-electronic signal regenerators-the so-called repeaters-optical amplifiers allow to remain in the pure optical domain of the transmission link without changing back to the electrical domain. this permitted the use of coherent light wave systems which surpass the still existing incoherent direct detection systems in an improvement in receiver sensitivity up to 20dB and in the efficiency of fiber bandwidth usage by working with smaller channel spacings in the WDM-technique, typically 1-10GHz [1]. An additional drawback of a repeater was its fixed bit-rate, so that by increasing the bit-rate all repeaters had to be replaced. Optical amplifiers, however, are nearly bit-rate transparent. Not only this transparency of the bit-rate counts to the advantage of optical amplifiers but also the fact to overcome the electrical bottleneck of an electronic repeater with typically 40-80Gbit/s [1].

The erbium-doped fiber amplifier EDFA has made tremendous progress since its invention in 1986. The optical amplifier has replaced the rather involved process of the fiber optic repeater station. It created a revolution in long distances optical Communication system. Simplicity and reliability of the repeater compartment are especially important when the optical fiber cable is used as a submarine cable [2]. By injecting laser pump light at a wavelength of 980 nm or 1480 nm into a strand of erbium-doped optical fiber, high optical gain at wavelengths between 1.5 and 1.6 μm can be obtained. EDFAs routinely amplify dozens of wavelengths simultaneously to compensate for signal power losses due to

splitting and propagation through optical fiber[3].Figure (1) show the general EDFA configuration.

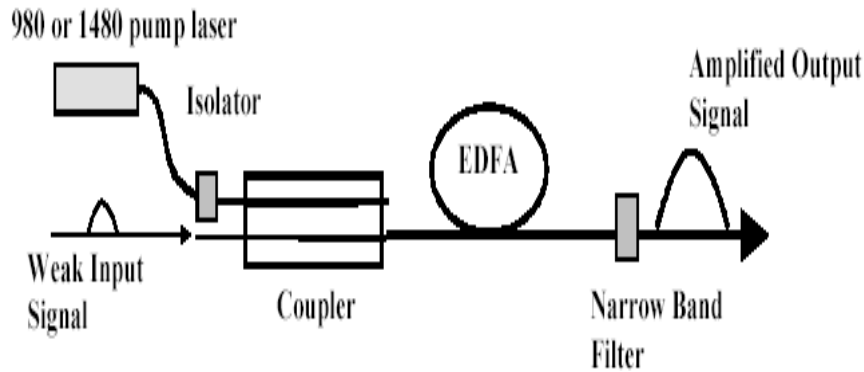

Fig.1 EDFA layout

2-Amplification Mechanism

Whereas semiconductor optical amplifiers use external current injection to excite electrons to higher energy levels, optical fiber amplifiers use optical pumping. In this process, one uses photons to directly raise electrons into excited states. The optical pumping process requires the use of three energy levels.

The top energy level to which the electron is elevated must lie energetically above the desired lasing level. After reaching its excited state, the electron must release some of its energy and drop to the desired lasing level. From this level, a signal photon can then trigger it into stimulated emission, whereby it releases its remaining energy in the form of a new photon with a wavelength identical to that of the signal photon. Since the pump photon must have a higher energy than the signal photon, the pump wavelength is shorter than the signal wavelength. To get a phenomenological understanding of how an EDFA works, we need to look at the energy-level structure of erbium.

The erbium atoms in silica are actual Er^{3+} ions, which are erbium atoms that have lost three of their outer electrons. In describing the transitions of the outer electrons in these ions to higher energy states, it is

common to refer to the process as "raising the ions to higher energy levels" Figure(2) shows a simplified energy-level diagram and various energy-level transition processes of these Er^{3+} ions in silica glass.

The two Principal levels for telecommunication applications are a metastable level (the so-called $^4I_{13/2}$ level) and the $^4I_{11/2}$ pump level. The term "metastable" means that the lifetimes for transitions from this state to the ground state are very long compared with the lifetimes of the states that led to this level.

The metastable, the pump, and the ground-state levels are actually bands of closely spaced energy levels that form a manifold due to the effect known as Stark splitting. Furthermore, each Stark level is broadened by thermal effects into an almost continuous band [4].

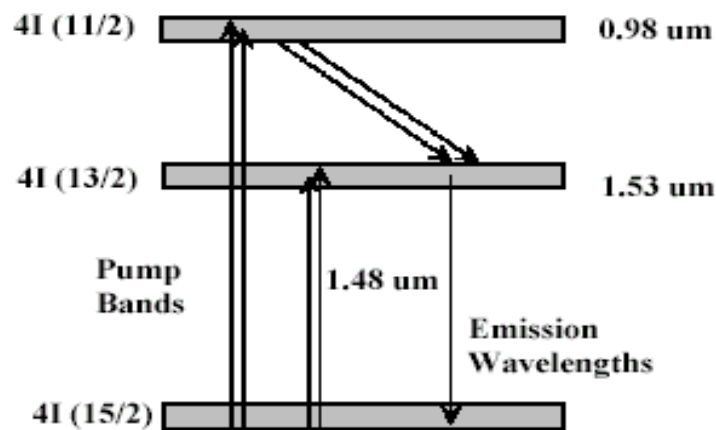

Fig(2) simplified energy-level diagram

3-Three-level pumping Scheme

Optical amplifiers amplify incident light through stimulated emission, the same mechanism used by lasers. In the case of erbium-doped fibers, the optical gain is supplied by the excited erbium ions (Er^{3+}) when the amplifier is pumped to achieve population inversion. depending on the energy states of the dopant.pumping schemes can be classified as a three or four-level scheme(see Fig.3).In both cases dopants are excited to a higher energy state(E_3) through absorption of pumped photons and then relax rapidly to a lower excited state (E_2).The stored energy is then used to amplify a signal beam through stimulated emission, thereby energy is transferred from the pump to the signal[5].

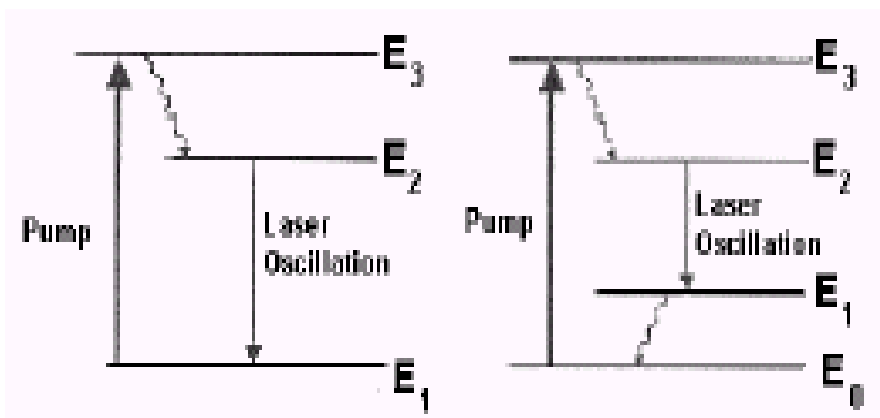

Fig(3) three or four level scheme

3.1 Rate Equations

To study the behavior of this 3-level system, a rate-equation approach is used to relate the various processes (spontaneous and stimulated emission, absorption, pumping) to the population in the three states.

The following processes contribute to the population (N_1) in state 1:

- Spontaneous emission from state 2 with a time constant τ_{21} .
- Stimulated emission from state 2 for amplification of the signal at a rate of W_s , which depends on the signal photon flux.
- Stimulated emission from E_3 at a rate W_p , which depends on the pumped photon flux.

The following processes depopulate state 1:

- Pumping (absorption of the pumped photons) at the rate W_p .
- Absorption of the signal photons at the rate W_s .

Therefore, the rate equation for the population in state 1 is[5]:

$$\frac{dN_1}{dt} = \frac{N_2}{\tau_{21}} + W_s(N_2 - N_1) - W_p(N_1 - N_3) \quad (1)$$

Similarly we can write the rate equations for the other two states[5]:

$$\frac{dN_2}{dt} = \frac{N_3}{\tau_{32}} - \frac{N_2}{\tau_{21}} - W_s(N_2 - N_1) \quad (2)$$

$$\frac{dN_3}{dt} = -\frac{N_3}{\tau_{32}} + W_p(N_1 - N_2) \quad (3)$$

3.2 population inversion Factor

In order to obtain gain, the stimulated emission from state 2 to state 1 must be greater than the absorption from state 1 to state 2. This condition implies that the population in state 2 must be maintained at a greater level than that of state 1. i.e. population inversion. The degree of population inversion is expressed by the population inversion factor n_{sp} [5]:

$$n_{SP} = \frac{N_2}{N_2 - N_1} \quad (4)$$

At steady-state, $\frac{dN_1}{dt} = 0$. We then obtain Eq.5 from Eq.1:

$$\frac{N_2}{\tau_{21}} + W_S(N_2 - N_1) - W_P(N_1 - N_3) = 0 \quad (5)$$

Since the decay τ_{32} from state 3 to state 2 is very fast, we can consider all the atoms that have been pumped to the excited state 3 will immediately decay to state 2. Therefore the population N_3 in state 3 can be simply obtained by the Boltzman distribution:

$$N_3 = N_2 e^{-(E_3 - E_2)/kT} \equiv \beta N_2 \quad (6)$$

Substituting Eq.6 into Eq.5 we obtain the population inversion factor n_{SP} after some manipulation:

$$n_{SP} = \frac{N_2}{N_2 - N_1} = \frac{W_P \tau_{21} + W_S \tau_{21}}{(1 - \beta) W_P \tau_{21} - 1} \quad (7)$$

Therefore, n_{SP} is related to the pump and signal powers by W_P and W_S , respectively, and to the pump wavelength by β . Eq.7 has important implications on both amplifier gain and ASE (amplified spontaneous emission) noise[5].

4-Amplifier Gain

In the steady state, the rate equation gives[6]:

$$N_2 - N_1 = \frac{W_P - 1/\tau_{SP}}{W_P + 2W_S + 1/\tau_{SP}} N_t \quad (8)$$

where τ_{sp} spontaneous emission time, $N_t \equiv N_1 + N_2$ is the total carrier density. When the pumping rate is high enough, or $W_p \gg W_s$ and $W_p \gg 1/\tau_{sp}$, $N_2 - N_1 \approx N_t$. In this case, the medium gain is approximately

$$g = \delta_e(N_2 - N_1) \approx \delta_e N_t = g^* \quad (9)$$

where δ_e emission cross-section, and δ_a is absorption cross-section, and g^* is the upper limit of the medium gain constant. From Eq.8 and the definition of g^* given by Eq.9[6].

$$g = g^* \frac{W_p - 1/\tau_{sp}}{W_p + 2W_s + 1/\tau_{sp}} \quad (10)$$

where:

$$W_p = \frac{\delta_a P_p}{hf_p A} \text{sec}^{-1}$$

$$W_s = \frac{\delta_e P_{in}}{hf_s A} \text{sec}^{-1}$$

Where A cross-section area, f_s input signal freq. and f_p pumped signal freq. the optimum length L is the point $W_p(L) = 1/\tau_{sp}$ or $N_2 = N_1$ where $P_p(z) = P_p(0)e^{-\delta_a N_t z / 2}$

$$L = \frac{2}{\delta_a N_t} \ln[P_p(0) \delta_a \tau_{sp} / hf_p A] \quad (11)$$

Where $p_p(z)$ pumping power at distance(z), and $p_p(0)$ pumping power at distance (0).

4.1 Gain spectrum and B.W:

The gain coefficient can be expressed as[7]:

$$g(w) = \frac{g_0}{1 + (w - w_0)^2 T_2^2 + P/P_s} \quad (12)$$

Where g_0 is small-signal peak gain, w is the optical frequency of the incident signal, w_0 is the transition frequency, P is the optical power of the incident signal, T_2 is the dipole relaxation time, and P_s is the saturation

power. Typically T_2 is small $< 1ps$, and the saturation power P_s depends on medium gain parameters such as the fluorescence time and the transition cross section. For no saturated (i.e. $P/P_s \ll 1$) the gain is at resonance). At non-resonant frequencies the gain follows the homogeneously broaden characteristics of a two level atom (i.e. Lorentzian profile). The gain B.W for this spectrum is typically expressed as the (Full Width at Half Maximum)FWHM[7].

$$\Delta\omega_g = 2/T_2$$

$$\Delta f_g = \frac{\Delta\omega_g}{2\pi}$$

(13)

4.2 Gain Saturation

Since $g(\omega)$ depends on the incident optical power when $P \approx P_s$, G will start to decrease with an increase in optical power p . Assume that the incident frequency is tuned for peak gain ($\omega = \omega_0$)

$$\frac{dp}{dz} = \frac{g_o P}{1 + P/P_s}$$

With the conditions $P(0) = P_{in}$ and $P(L) = P_{out} = GP_{in}$ the large signal amplifier gain becomes[7]:

$$G = g_o \exp\left(-\frac{G-1}{G} \frac{P_{out}}{P_s}\right)$$

(14)

5. Amplifier noise

Spontaneous emission in the amplifier will degrade the SNR due to the addition of ASE noise during the amplification process. SNR degradation is quantified through the amplifier noise figure F_n [7]:

$$F_n = \frac{(SNR)_{in}}{(SNR)_{out}}$$

(15)

where

$$SNR_{in} = \frac{P_{in}}{2hfB_e}, \quad SNR_{out} = \frac{GP_{in}}{4S_{sp}B_e}$$

Where B_e is transmission $B.W$

The spontaneous emission contribution is amplified along with the signal. The spectral density of the spontaneous emission induced noise is nearly constant(white noise)and can be expressed as[7,8]:

$$S_{SP}(f) = (G - 1)n_{SP}hf \quad (16)$$

and the amplifier noise figure is[8]:

$$F_n = 2n_{SP}(G - 1)/G \approx 2n_{SP} \quad (17)$$

For most amplifier $F_n > 3dB$ and can be $6 - 8dB$.

6.Results and discussion

Erbium amplifiers work in all the optical communication system whether they are digital or analog. In our study, we have used the single-mode optical fiber whose diameter is between $1 \mu m$ to $10 \mu m$. The properties of the erbium amplifiers were studied and the effects of the quantities that take part in the performance of these amplifiers were investigated.the table (1) show some the value that using in this simulation.

value	Parameters
10.8ms or 10ms	τ_{SP}
$1 * 10^{-20} \text{ cm}^2$ at 980nm $2 * 10^{-20} \text{ cm}^2$ at 1480nm	δ_a
$8 * 10^{-20} \text{ cm}^2$ at 1540nm	δ_e
$6.63 * 10^{-34} \text{ Js}$	h
$8 * 10^{18} \text{ cm}^{-3}$	$Nt = N1 + N2$
0.1 ps	T
1.48	$n1$
$1 \mu m - 10 \mu m$	A_{core}
$3 * 10^8 \text{ m/s}$	c

Table (1)The value parameter

6.1 The effect of pumping rate on Amp. gain:

In our study, we have used two types of pumps with the following wavelengths(980nm,1480nm).The threshold power of every type of these pumps was calculated by using the following equation:

$$P_p \gg P_p^{th} = \frac{hf_p A}{\delta_a \tau_{sp}} \quad (18)$$

The threshold power of the pump with the wavelength (1480nm) is (0.682mw), and of the pump with the wavelength (980nm) is (1mw).Fig.(4) shows the effects of pumping power on amplifiers with the change in the incident optical signal which has to be amplified when the wavelength of the optical pump is (1480nm).Fig.(4) shows the increase in pumping power with a corresponding increase in the value of the amplifier gain. The increase in the value of the amplifier gain is nearly linear at the beginning(due to the increase in the stimulated carriers in the meta-stable level with the increase of the pumping signal photons).The value of the amplifier gain becomes nearly stable with the increase in the pumping power, because the stability in the value of the amplifier gain at a certain pumping power mean that all the carriers at the ground level were stimulated to reach the meta-stable level with a power less than that power which caused the stability in the amplifier gain value (one can get rid of the excessive power by placing a de-coupler after the amplifier, it would keep the excessive pumping power away from the output signal of the amplifier which one can make use of this excessive power through controlling the pumping power (feedback)).

Fig.(4) illustrates the change in the input signal power with the change in pumping power. We figure out the increase in the power of the incident optical effects on the amplifier gain (any increase in the photon's of the incident optical signal needs an increase in the number of carriers in the meta-stable level which in turn needs an increase in the pumping signals photons).

This means the carriers number in the meta-stable level must be equal or greater than the photon's number of the incident optical signal to avoid the amplifier getting into the saturation region).

Fig.(5) shows the effect of the pumping power on the amplifier gain with the change in the power of the incident optical signal when the wavelength of the pump is(980nm).This Fig. Illustrates the same effect which is shown in Fig.(4)with the difference in values. we can see that the values which were presented in Fig.(4) are greater than the ones in Fig.(5)(using the 1480nm wavelength pump gives a whole population inversion to the contrary of using the 980nm wavelength pump for the latter does give a whole population inversion).

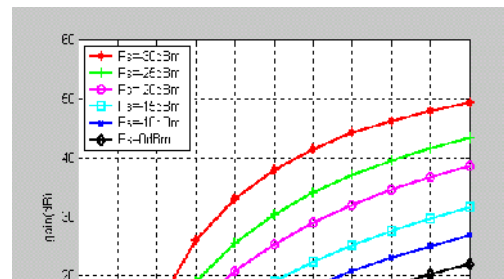
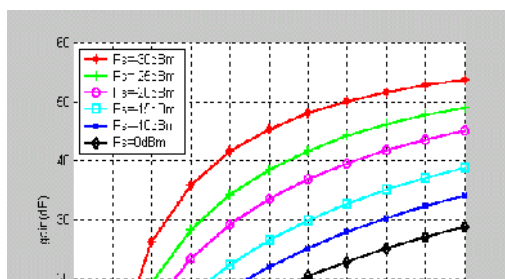
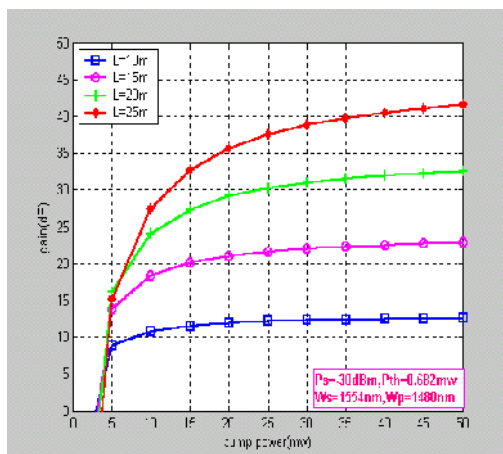

Fig.(6) illustrates the pumping power effect (the wavelength of the pump is (1480nm)) on the amplifier gain with the change in the amplifier length. The increase in the amplifier length causes an increase in the amplifier gain, which is necessary for an increase in the pumping power.(A 10m length needs a greater pumping power of about 20mw,and a length of 15m needs a greater pumping power of about 35mw).i.e. the pumping power increases with the increase in the amplifier length.The increase in the amplifier length means more carriers at the ground level (more doping),which needs an increase in the pumping power so as to stimulate all the carriers exist on the ground level to get the meta-stable level.

Fig.(7) shows the effect of the pumping power on the amplifier gain with the change in the amplifier length (the wavelength of the pump is 980 nm). This figure shows the same effect that was illustrated on Fig.(6) with the differences in values at the change of the pumping power.



Fig(6) amp. gain vs. pumping power for diff. amp. Length ($\lambda_p = 1480 \text{ nm}$)

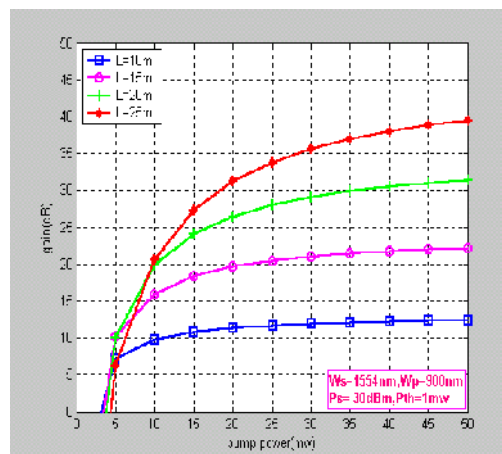

Fig.(7) amp. gain v.s. pumping power for diff. amp. length ($\lambda_p = 980 \text{ nm}$)

6.2 The effect of the amp. Length on its gain:

Fig.(8) illustrates the effect of the amp. Length on its gain when the pumping power is changed during the use of a (1480nm) wavelength optical pump when the input power is(-60dBm).This Fig. shows the increasing effect of the amplifier length on its gain. The increase in the amp. Length results in an increase of its gain when there is a suitable pumping power in accordance with the increase of the length.In other words, the increase in the Amplifier length causes an increase in the number of carriers at the ground level (dopping increase)which in turn entails an increase in the pumping power so as to be stimulated to the meta-stable level. The increase in the amp. gain is due to the increase of the carriers in the meta-stable level, because these carriers are stimulated by the incident optical signal. In addition to that, the resulting photons of the stimulated process will participate in the stimulated carriers at the meta-stable level. The process takes place depending on the amp. length (i.e., the number of photons will double due to the increase of the length).We also notice that the gain value increases with the increase in the amp. length till it reaches the highest value at a certain length, then the value decreases with the increase of the length. This effect(the gain increase) results from the pumping power being suitable with the increase in the length of the amp. till a definite length. The decrease in the gain is because of the lack of the necessary pumping power to fulfill the population inversion phenomenon completely on the amp. length (i.e., the pumping power will get lower when passing gradually through the amp. whereas the length increases).

It can be noticed that highest gain value will be (17dB) when the pumping power is (5mw) at the time when the amp. length is (13.5m). We can also notice the increase in the pumping power from (5mw) to (10mw) at a similar length (13.5m), thus the gain will increase from (17dB) to (25dB). It is also noticed that as the pumping power increases to (25mw), an increase in the gain (32dB) will take place for the same length. There should be some matching among the needed gain value, the amp. gain, and the pumping power in order to get the best performance at the cheapest price.

Fig.(9) shows the same effect which is shown in Fig.(8) but with difference in the amp. gain when using an optical pump With a (980nm) wavelength. It can be noticed that there is an effect on the part of the wavelength of the optical pump in use on the gain value in comparison with the gain in Fig.(8) with the same input power and the same change in the pumping power.

The gain value goes lower with a (980nm) wavelength optical pump as compared to the gain when a (1480nm) wavelength optical pump is used. The reason behind the difference is due to the full Population inversion given by a (1480nm) wavelength optical pump, the thing that differs completely from using a (980nm) wavelength optical pump which does not offer a full population inversion.

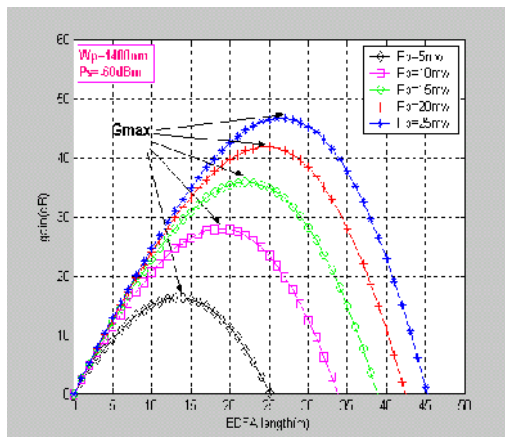

Fig.(8) amp. gain vs. EDFA length for diff. value of pump power ($\lambda_p = 1480nm$)

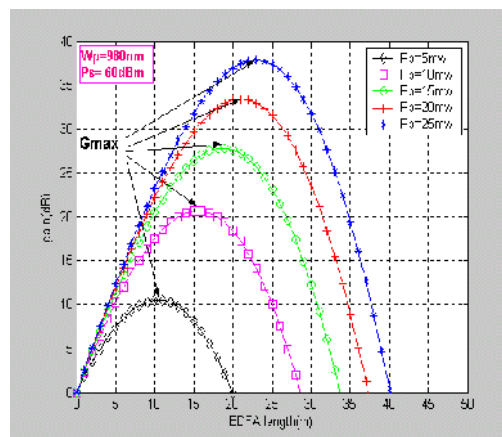

Fig.(9) amp. gain vs. EDFA length for diff. value of pump power ($\lambda_p = 980nm$)

6.3 The effect of the input optical signal power on the amp. gain:

Fig.(10) highlights the effect of the input signal power on the amp. gain with a (10mw) pumping power when a (1480nm) wavelength optical pump is used.

We can figure out the effect of the increase in the input power on the amp. which causes the amp. to get into the saturation region. The reason

behind that is that the number of carriers in the meta-stable level is less than the photons of the input optical signal. By viewing Fig.(10), we can calculate the saturation power. This figure shows that it is about (-17dB), which means that the amp. will get into the saturation region for the input signal power is (-17dB) or more.

Fig.(11) highlights the input signal power on the amp. gain with a (10mw) pumping power and a (20m) amp.length. Drawing a comparison with Fig.(10), we notice that the saturation power will increase when the pumping power increases with the same amp. length (20m), where the saturation power (-15dB). It is also noticed that the amp. gain is increased because of the increase in the pumping power. This effect is a result of the increases in carriers number in meta-stable level.

Fig.(12) presents the effect of the input signal power on the gain with a (10mw) pumping power and a (15m) length. Comparing it to Fig.(10), we notice that the saturation power will increase when amp. length decreases with the same pumping power that used in Fig.(10). for which the saturation power is equal (-17dB). Also the same result is show in Fig.(11).

Fig.(13) presents the effect of the input signal power on the gain with a (15mw) pumping power and a (15m) amp. length. Comparing it to Fig.(10), we notice that the saturation power increase from (-17dB) to (-14dB), the same thing applies to the amp. gain. The increase in the saturation power entails an increase in the pumping power (if the carriers on the ground level are greater in number), this assumes a greater pumping power is needed to stimulate, all carriers for the meta-stable level.

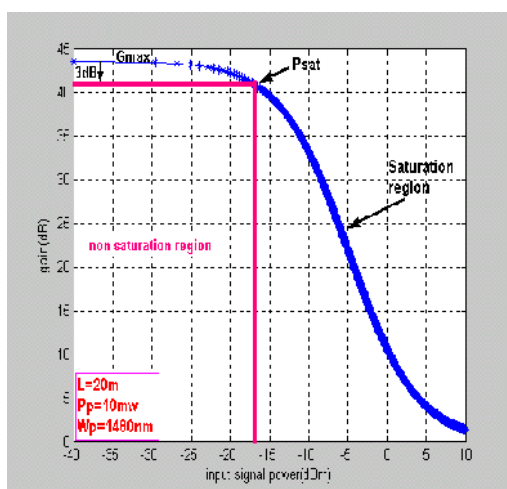

Fig.(10) amp.gain vs. input signal power ($\lambda_p = 1480nm$)

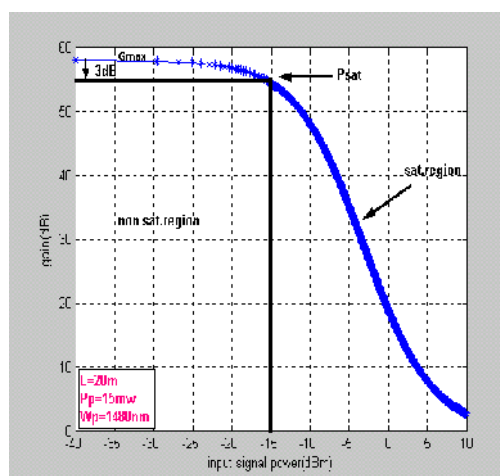

Fig.(11) amp. gain vs. input signal power ($\lambda_p = 1480nm$)

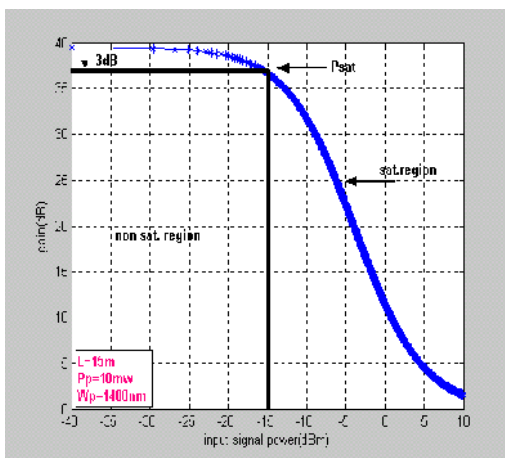

Fig.(12) amp.gain vs. input power
 ($\lambda_p = 1480nm$)

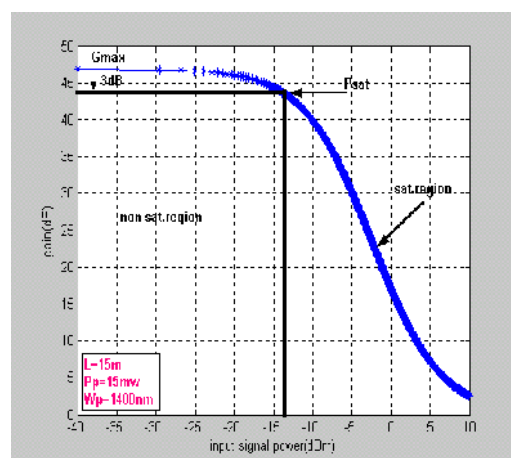

Fig.(13) amp.gain vs. input signal
 power ($\lambda_p = 1480nm$)

The carriers number at this level is equal to the optical signal photons or is greater. when all the carriers at the ground level are stimulated, an increase in the length (dopping increase) is needed with a suitable pumping power increase to increase the saturation power (prevent the

amp. From getting into the saturation region). Figures (14),(15),(16) and (17) show the same effect that was presented in previous Figures when using (1480nm) wavelength optical pump.

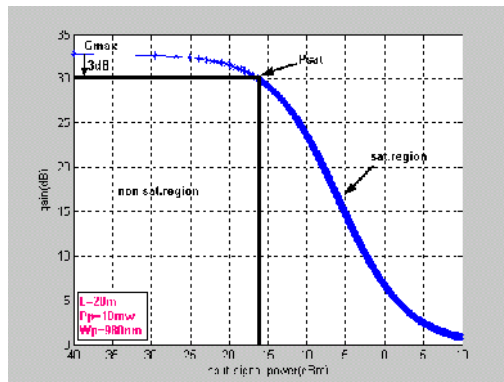

Fig.(14) amp. gain vs. input power ($\lambda_p = 980nm$)

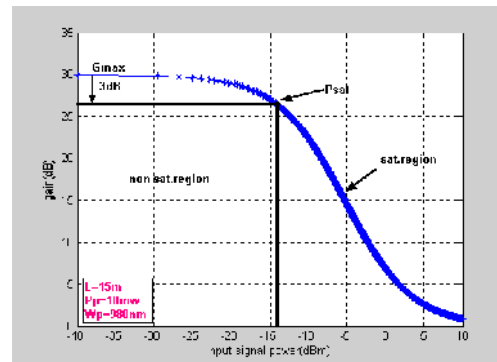

Fig.(16) amp.gain Vs. input power ($\lambda_p = 980nm$)

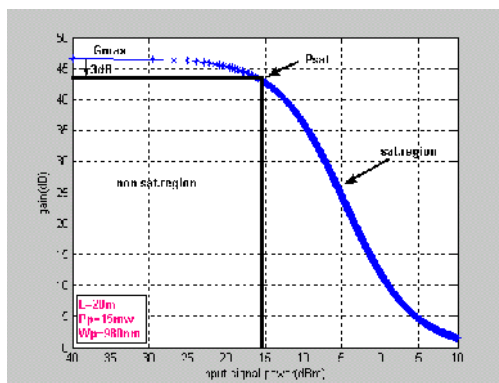

Fig.(15) amp, gain vs., input power

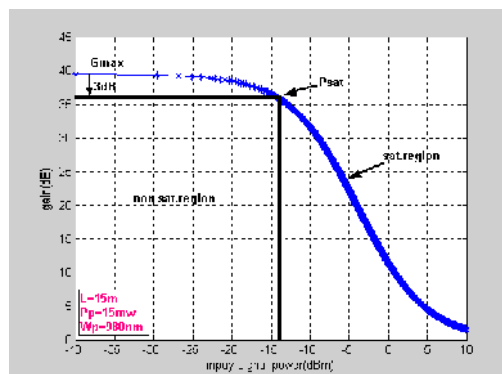

Fig.(17) amp.gain vs. input power (

6.4 The effect of the amplified spontaneous emission (ASE)

Fig.(18) illustrates the output spectrum of the Erbium amplifier. One can notice the effect of the (ASE) on the output signal value and the amplifier gain, when the input signal value is (0dBm) and the pumping power is (25mw) and the amp. length is (22m).the (ASE) value is between (-41,-32) and the value of the amp. gain is about (18dB).

Figures (19),(20), and (21) show the effect of changing the quantities that participate in the performance of the EDFA .(the amp length, the input optical signal value, and the pumping power. on the (ASE) it is noticed that the value of this power changes with the changes in amp. length and the change of the power of the input optical signal (that means there should be some matching between the signal power which is to be amplified and the carriers number at the meta-stable level. That is to say,

the amp. design has to be chosen taking seriously in to account the amp. so as to come up with the best performance.

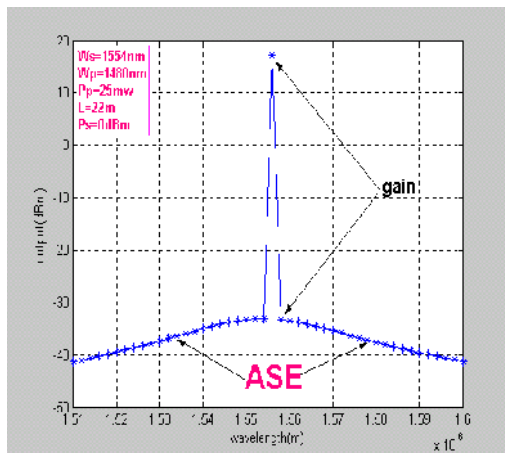

Fig.(18) output power vs. transition wavelength

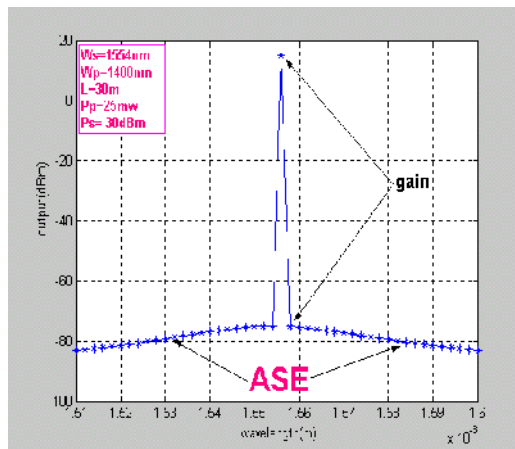

Fig.(20) o/p power vs. transition wavelength

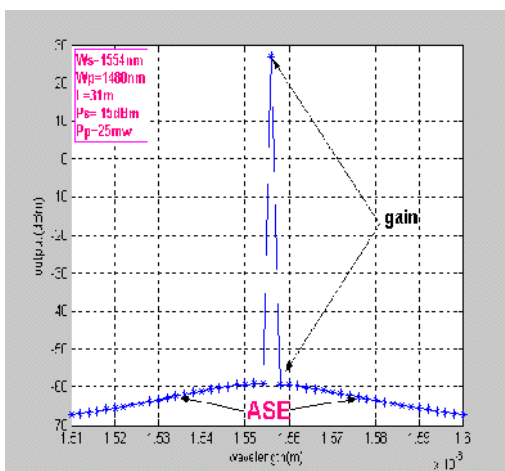

Fig.(19) o/p power vs. transition wavelength

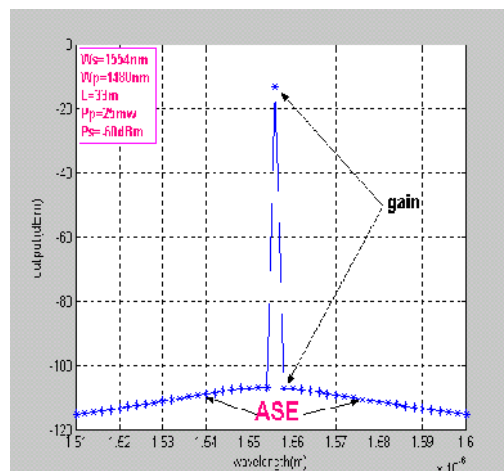

Fig.(21) o/p power vs. transition power

Fig.(22) shows the opposite relation between the amp. gain spectrum and the noise signal spectrum with the change in the transition wavelength of the Erbium ions. Fig.(23) shows that it is possible to get the minimum noise signal value (3dB) in the EDFA, this can be done through the proper choice of the length value (29m) and a pumping power (25mw) with a wavelength of the pump (1480nm), when the input optical signal value is (0dBm). A (62dB) gain value was obtained with a noise signal of (3.02 to -3.02)dB

Fig.(24) shows the opposite relation between the gain saturation and the noise signal with the change in the input optical signal value when a (1480nm) wavelength optical pump is employed with the (25mw) pumping power and the (29m) length. we can clearly notice the increase in the noise signal when the amp. gets into saturation region.

Fig.(25) illustrates the relation between, the saturation gain and the noise figure (NF) when the (980nm) wavelength optical pump is used with the same values of Fig.(24). The change in the noise figure is clear when quality of the optical pump is changed.

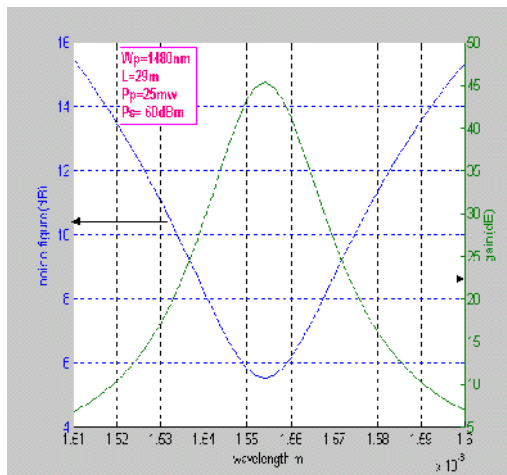

Fig.(22) NF and amp.gain vs. tran.wavelength

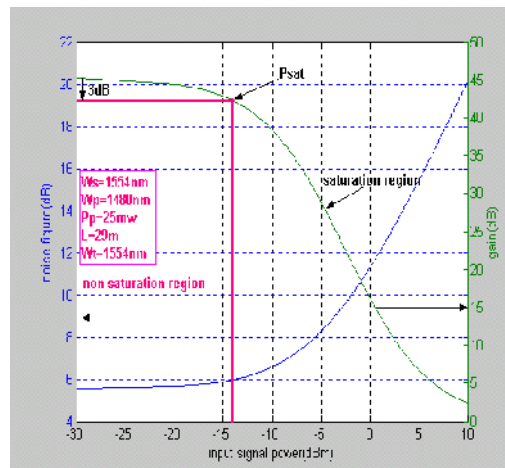

Fig.(24) NF and gain sat. vs. I/p power ($\lambda_p = 1480 \text{ nm}$)

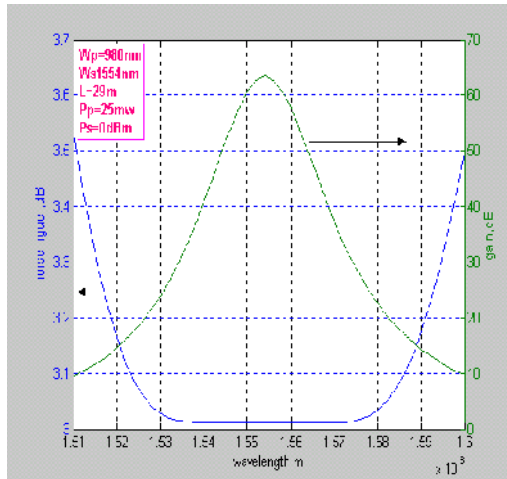

Fig.(23) NF and amp. gain vs. tran. wavelength

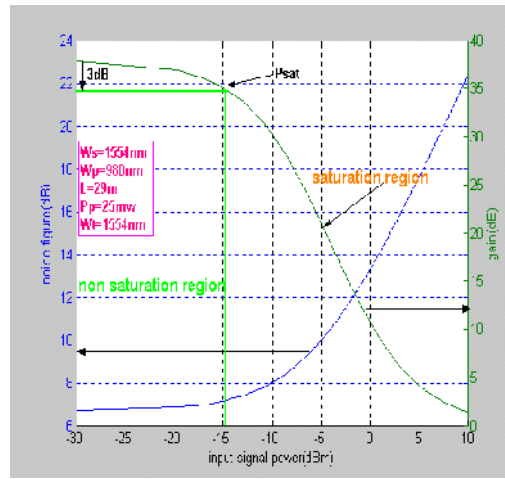

Fig.(25) NF and gain sat. vs. 1/p power ($\lambda_p = 980nm$)

6.5 The effect of the cross-section ratio of absorption on the cross-section of emission:

Fig(26) presents the effect of the absorption cross-section value on that of the emission which is (s%) with an input power of (-60dBm) and a pumping power of (5mw) to (25mw) when the (1480nm) wavelength optical pump is used. We can notice the effect of this ratio on the amp. gain which in turn get lower (decreases) as this ratio increases. This effect is caused by the decreases that takes place in the number of the stimulated carriers in the meta-stable level as the this ratio increases. This means that the carriers quantity that can be stimulated in the meta-stable level is small. that is to say that this quantity adopts an opposite attitude as compared to the emission cross-section. Consequently, by viewing this figure, the best ratio is (25%) to come up with the best performance of the amp.(the best gain). This ratio is adopted in our study. The cross-section of emission has to be greater than that of absorption as to hold all the stimulated carriers coming from the ground level at the meta-stable level.

Fig.(27) shows the same effect that prevailed in Fig.(26) with some difference in the resulting values when employing a (980nm) wavelength optical pump.

Fig.(28) shows the change effect of the ratio on the amp.gain with the change in the pumping power when a (1480nm) wavelength optical pump is used.We can acquaint the effect of this ratio on the amp. gain (it decreases with the increase of this ratio).Also, Fig.(29) shows the same effect as in Fig.(28) with some differences in the resulting values when using a (980nm) wavelength optical pump.The effect that was made clear on the gain when increasing the ratio is due to the fact that the number of the stimulated carriers, belonging to the optical pump, from the ground level to the meta-stable level, their number increases with the increases in the pumping power.Thus,there should be enough (area) space to hold this quantity of carriers. Since the emission cross-section area decreases with the increase in this ratio, that means the number of carriers that can be stimulated will get lower, which lead to lessen the gain.

Fig.(30) shows the effect of the (S) ratio on the output power of the amp. with the change in the input power when using a (1480nm) wavelength optical pump. The effect of this ratio on the output power will get lower in this ratio because of the previously mentioned reasons.Fig.(31) shows same effect that shown in Fig.(30) has with some difference in the resulting values when using a (980nm) wavelength optical pump. From the previously-illustrated figures, one can see the effect of this ratio on the work and performance of the EDFA.The emission cross-section area has to be greater than that of the absorption cross-section, so as to obtain the best performance of the amplifier. This means getting the greatest number of carriers that can be hold at the meta-stable level to be stimulated by the photons of the input optical signal that is going to be amplified. Also, this helps to prevent the amplifier from getting into the saturation region, because increasing the number of the carriers that exist at the meta-stable level means providing the greatest number of the input optical signal photons. Consequently, the best ratio to be obtained is (25%).This means that the emission cross-section area is equal to or greater than 4 times the area of the absorption cross-section.

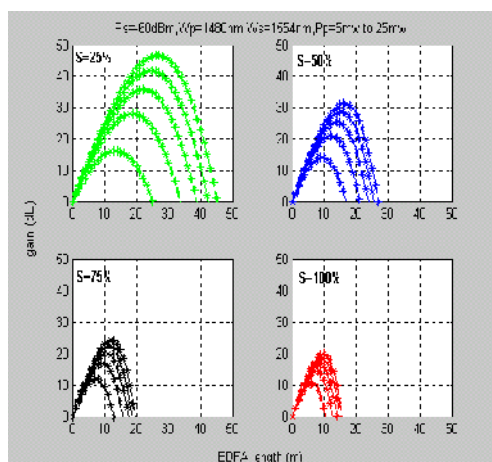

Fig.(26) amp.gain vs. EDFA length ($\lambda_p = 1480nm$)

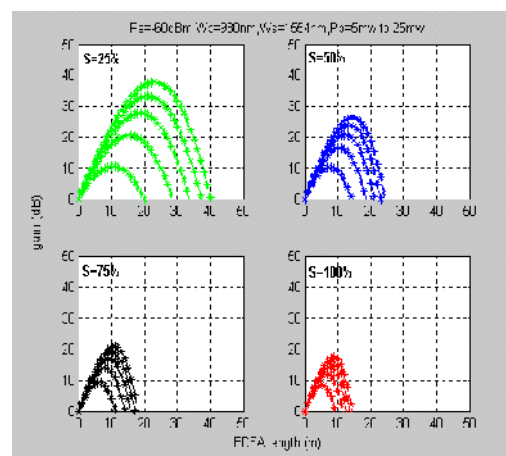

Fig.(27) amp.gain vs. EDFA length ($\lambda_p = 980nm$)

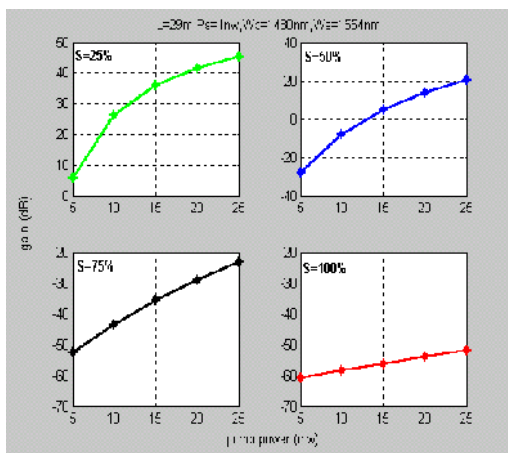

Fig.(28) amp.gain vs. pumping power ($\lambda_p = 1480nm$)

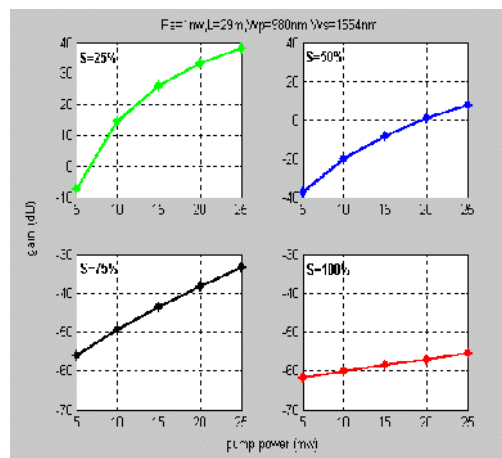
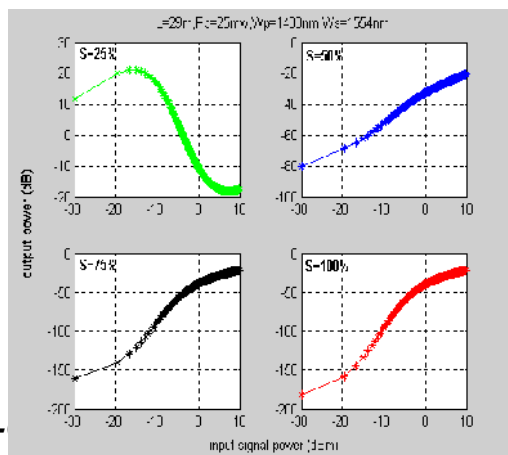

Fig.(29) amp.gain vs. pumping power ($\lambda_p = 980nm$)



7-

Fig.(30) o/p power vs. I/p power ($\lambda_p = 1480nm$)

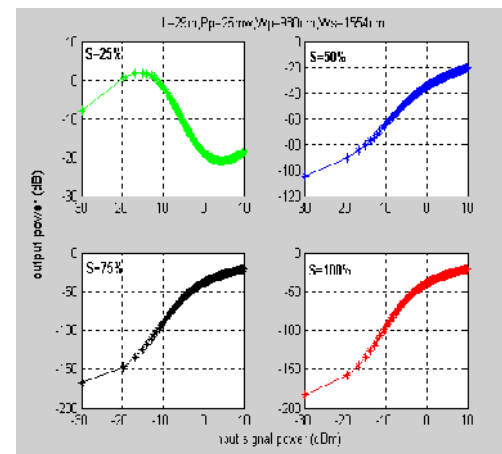

Fig.(31) o/p power vs., I/p power ($\lambda_p = 980nm$)

The results obtained show the effects of the parameters that contribute to the dynamic operation of EDFA. The first step in designing any amplifier, starts with finding the amplifier best length as illustrated in equation (11) and then choosing the value of the appropriate pumping power for that length. Any increase in the amplifier length means an

increase in the doping concentration which requires in turn an increase in the pumping power which harmonize this increase in the doping concentration. The results indicate the effect of the input signal power which is required to be amplified upon the amplifier gain, there must be an efficient concentration of the stimulate carriers in the metastable level to grasp all the photons of the incident optical signal in order to avoid the entrance of the amplifier into the saturation region. The results also show effect of the absorption cross section ratio upon that of the emission cross section. This conclusion shows that the best area for the emission cross section must be twice or more than the area of the absorption cross section in order to grasp all the carriers available in the ground level.

The conclusions illustrate the effect of the wavelength of the optical laser pump utilized on the amplifier gain. It shows the difference between using the optical pump with wavelength of (1480nm) and an optical one with wavelength of (980nm) on the amplifier gain values. We note that utilizing the first one is better than utilizing the second in order to get the best performance of the amplifier.

The results also indicate the best operating wavelength (1550 nm) which represents the third optical fiber window, which gives minimum input signal power, better bit error rate, and higher data rate.

8-References

[1]. Frank Ellrich, Remigius Zengerle, "**Broadband Optical Fiber Amplifier**", University of Kaiserslautern, Chair of Electrodynamics and Optical Communications, 67663 Kaiserslautern, Germany, 2002
E-mail: ellrich@rhrk.uni-kl.de zengerle@rhrk.uni-kl.de.

[2]. Keigo Iizuka, "**ERBIUM-DOPED FIBER AMPLIFIER**", Laboratory Instruction Notes, Faculty of Applied Science and Engineering University of Toronto Canada, Revised April 2003.

[3]. Douglas M. Baney, Philippe Gallion, Rodney S. Tucker, "**Theory and Measurement Techniques for the Noise Figure of Optical Amplifier**", Australian Photonics Cooperative Research Centre, Department of Electronic Engineering, University of Melbourne, Parkville, Victoria 3052, Australia, December 29, 2000, web site: www.idealibrary.com.

[4]. Gerd Keiser, "**Optical Fiber Communications**", McGraw-Hill Higher Education, International Editions 2000, and the web site www.mhhe.com.

[5]. Li Qian, "Experiment on Erbium-Doped Fiber Amplifiers", Advanced Labs for Special Topics in Photonics (ECE1640H), University of Toronto, April 28, 1998.

[6]. Max Ming-Kang Lin "Principles and Applications of optical Communication", McGraw-hill, New York, 1998.

[7]. H. Aghababaeian, T. Toosi, N. Granpayeh, "Gain Broadening Erbium Doped Fiber Amplifiers for WDM Networks", Elec. Eng Dept., K.N. Toosi Univ. of Technology, P.O. Box 16315-1355, Tehran, Iran, E-mail: T-Toosi@yahoo.com, September 2002

[8]. Jean-Pierre Laude "DWDM Fundamentals, Components, and applications" Artech House Boston. London, 2002
www.artechhouse.com

