

**Design Fuzzy Self Tuning of PID Controller for
Chopper-Fed DC Motor Drive**

Maher M.F. Algreer

Yhya R.M.Kuraz

maher.algreer@gmail.com

Yhya_kuraz@yahoo.com

College of Engineering / Computer Engineering Department

Abstract

Tuning the parameters of a PID controller is very important in PID control. Ziegler and Nichols proposed the well-known Ziegler-Nichols method to tune the coefficients of a PID controller. This tuning method is very simple, but cannot guarantee to be always effective. For this reason, this paper investigates the design of self tuning for a PID controller. The controller includes two parts: conventional

PID controller and fuzzy logic control (FLC) part, which has self tuning capabilities in set point tracking performance. The proportional, integral and derivate (K_P , K_I , K_D) gains in a system can be self-tuned on-line with the output of the system under control. The conventional PI controller (speed controller) in the Chopper-Fed DC Motor Drive is replaced by the self tuning PID controller, to make them more general and to achieve minimum steady-state error, also to improve the other dynamic behavior (overshoot). Computer Simulation is conducted to demonstrate its performance and results show that the proposed design is success over the conventional PID controller.

Keywords: PID controller, Fuzzy logic control, Self tuning controller, Chopper fed-DC motor drive.

تصميم مولف ذاتي مضرب للمسيطر التناسبي-التكاملي-التفاضلي في دائرة التغذية لمقطع سواقة محرك التيار المستمر

يحيى رجب محمد كراز

ماهر محمد فوزي ال غريير

جامعة الموصل / كلية الهندسة/ قسم هندسة الحاسبات

الخلاصة

إن من العوامل المهمة في أنظمة السيطرة باستخدام المسيطر (التناسبي-التكاملي-التفاضلي) PID هو توليف المعاملات لهذا المسيطر. اقترح الباحثان Ziegler و Nichols نظرية لتوليف معاملات المسيطر PID، والتي تعتبر بسيطة لكنها غير كفوءة دائماً. لهذا السبب تم في هذا البحث تصميم مولف ذاتي للمسيطر PID. يحتوي المسيطر المقترح على جزئين الأول مسيطر PID تقليدي والثاني مسيطر المنطق ال FLC والذي يمتلك قابلية التنعيم الذاتي لتتبع معاملات المسيطر PID وهي المكاسب K_P K_I .

K_D يمكن تغيير أنيا السيطرة. المسيطر PI التقليدي (مسيطر المقطع التغذية لسواقة المحرك المستمر، بالمسيطر المصمم، ليكون أكثر شمولا وللحصول على اقل نسبة خطأ وكذلك لتقليل العوامل الديناميكية الاخرى مثل تجاوز الحد. استخدمت المماثلة عبر الحاسب الآلي لدراسة أداء المسيطر المصمم وقد أظهرت النتائج نجاح التصميم المقترح وتفوقه على المسيطر التقليدي.

Received 7 Dec. 2006

Accepted 3 July 2007

1. Introduction

Fuzzy logic control (FLC) is one of the most successful applications of fuzzy set theory, introduced by L.A Zadeh in 1973 and applied (Mamdani 1974) in an attempt to control system that are structurally difficult to model. Since then, FLC has been an extremely active and fruitful research area with many industrial applications reported [1]. In the last three decades, FLC has evolved as an alternative or complementary to the conventional control strategies in various engineering areas. Fuzzy control theory usually provides non-linear controllers that are capable of performing different complex non-linear control action, even for uncertain nonlinear systems. Unlike conventional control, designing a FLC does not require precise knowledge of the system model such as the poles and zeroes of the system transfer functions. Imitating the way of human learning, the tracking error and the rate of the error are two crucial inputs for the design of such a fuzzy control system [2][3].

Despite a lot of research and the huge number of different solutions proposed, most industrial control systems are base on conventional PID (Proportional-Integral-Derivative) regulators. Different sources estimate the share taken by PID controllers is between 90% and 99%. Some of the reasons for this situation may be given as follows [4]:

- a) PID controllers are robust and simple to design.
- b) There exists a clear relationship between PID and system response parameters. As a PID controller has only three parameters, plant operators have a deep knowledge about the influence of these parameters and the specified response characteristics on each other.
- c) Many PID tuning techniques have been elaborated during recent decades, which facilitates the operator's task.
- d) Because of its flexibility, PID control could benefit from the advances in technology. Most of the classical industrial controllers have been provided with special procedures to automate the adjustment of their parameters (tuning and self-tuning).

However, PID controllers cannot provide a general solution to all control problems. The processes involved are in general complex and time-variant, with delays and non-linearity, and often with poorly defined dynamics. When the process becomes too complex to be described by analytical models, it is unlikely to be efficiently controlled by conventional approaches. In this case a classical control methodology can in many cases simplify the plant model, but does not provide good performance. Therefore, an operator is still needed to have control over the plant. Human control is vulnerable, and very dependent on an operator's experience and qualification, and as a result many PID controllers are poorly tuned in practice. A quite obvious way to automate the operator's task is to employ an artificial intelligence technique. Fuzzy control, occupying the boundary line between artificial intelligent and control engineering, can be considered as an obvious solution, which is confirmed by engineering practice. According to the survey of the Japanese control technology industry conducted by the Japanese Society of Instrument and Control Engineering, fuzzy and neural control constitute one of the fastest-growing areas of control technology development, and have even better prospects for future [4].

Because PID controllers are often not properly tuned (e.g., due to plant parameter variations or operating condition changed), there is a significant need to develop methods for the automatic tuning of PID controllers. While there exist many conventional methods for the automatic tuning of PID controllers, including hand tuning, Ziegler-Nichols tuning, analytical method, by optimization or, pole placement [5]. If a mathematical model of the plant can be derived, then it is possible to apply various design techniques for determining parameters of the

controller that will meet the transient and steady-state specification, of the closed-loop system. However, if the plant is so complicated that its mathematical model cannot be easily obtained, then an analytical approach to design of a PID controller is not possible. Then we must resort to experimental approaches to tuning PID controller [6].

2. Fuzzy PID Self Tuning

The basic structure of the PID controller is first described in the following equations as well as fig.1.

$$U^{PID} = K_p e + K_I \int e dt + K_D \frac{de(t)}{dt} \quad (1)$$

$$U^{PID} = K_P \left(e + \frac{1}{T_I} \int e dt + T_d \frac{de(t)}{dt} \right) \quad (2)$$

Where e is the tracking error, conventional PID control is a sum of three different control actions. The proportional gain K_P , integral gain K_I , and derivative gain K_D , represent the strengths of different control action. Proportional action can reduce the steady-state error, but too much of it can cause the stability to deteriorate. Integral action will eliminate the steady-state. Derivative action will improve the closed loop stability. The relationships between these control parameters are:

$$\begin{aligned} K_I &= K_P / T_i \\ K_D &= K_P * T_d \end{aligned} \quad (3)$$

Where T_I , and T_D are integral time and derivative time respectively [1].

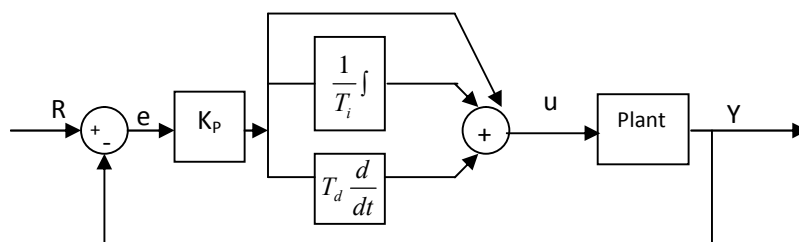

Fig.1: PID control in the closed loop.

This paper proposed two inputs-three outputs self tuning of a PID controller. The controller design used the error and change of error as inputs to the self tuning, and the gains (K_{P1} , K_{I1} , K_{D1}) as outputs. The FLC is adding to the conventional PID controller to adjust the parameters of the PID controller on-line according to the change of the signals error and change of the error. The controller proposed also contain a scaling gains inputs (K_e , $K_{\Delta e}$) as shown in fig.2, to satisfy the operational ranges (the universe of discourse) making them more general.

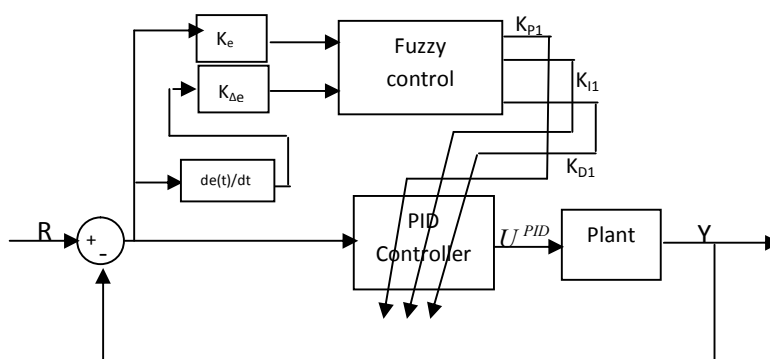

Fig.2: Fuzzy self tuning proposed.

Now the control action of the PID controller after self tuning can be describing as:

$$U^{PID} = K_{P2}e(t) + K_{I2} \int edt + K_{D2} \frac{de(t)}{dt} \quad (4)$$

Where K_{P2} , K_{I2} , and K_{D2} are the new gains of PID controller and are equals to:

$$K_{P2} = K_{P1} * K_P, K_{I2} = K_{I1} * K_I, \text{ and } K_{D2} = K_{D1} * K_D \quad (5)$$

Where K_{P1} , K_{I1} , and K_{D1} are the gains outputs of fuzzy control, that are varying online with the output of the system under control. And K_P , K_I , and K_D are the initial values of the conventional PID.

The general structure of fuzzy logic control is represented in fig.3 and comprises three principal components [5]:

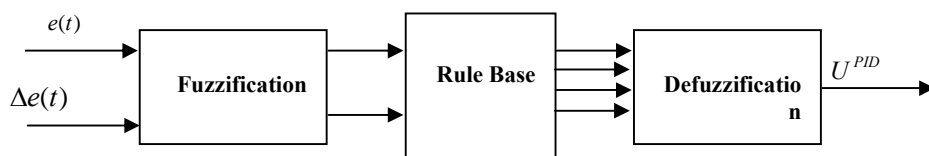

Fig.3: Fuzzy logic control structure.

1) Fuzzification: This converts input data into suitable linguistic values. As shown in Fig .4, there are two inputs to the controller: error and rate change of the error signals. The error is defined as:

$$e(t) = r(t) - y(t)$$

Rate of error is defined as it follows:

$$\Delta e(t) = \frac{de(t)}{dt}$$

Where $r(t)$ is the reference input, $y(t)$ is the output, $e(t)$ is the error signal, and $\Delta e(t)$ is the rate of error. The seventh triangular input and output member ship functions of the fuzzy self tuning are shown in the figs. (4,5). For the system under study the universe of discourse for both $e(t)$ and $\Delta e(t)$ may be normalized from $[-1,1]$, and the linguistic labels are {Negative Big, , Negative medium, Negative small, Zero, ,Positive small, Positive medium, Positive Big }, and are referred to in the rules bases as {NB,NM,NS,ZE,PS,PM,PB },and the linguistic labels of the outputs are {Zero, Medium small, Small, Medium, Big, Medium big, very big} and refereed to in the rules bases as {Z,.MS, S, M, B, MB, VB}.

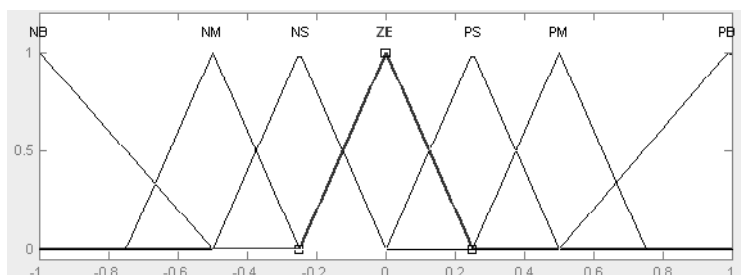

Fig.4: Member ships function of inputs (e , Δe).

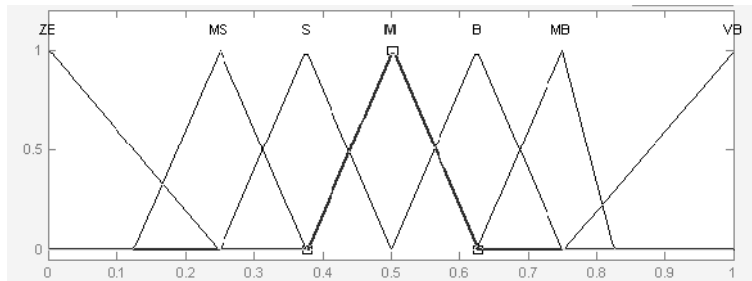

Fig.5: Member ships functions of outputs (K_{p1} , K_{i1} , and K_{d1}).

2) Rule base: A decision making logic which is, simulating a human decision process, inters fuzzy control action from the knowledge of the control rules and linguistic variable definitions. The basic rule base of these controllers' types is

$$IF e(t) \text{ is } E_i \text{ and } \Delta e(t) \text{ is } \Delta E_j \text{ then } U_p \text{ is } U_{p1}, U_I \text{ is } U_{I1}, \text{ and } U_D \text{ is } U_{D1} \quad (6)$$

given by:

Where E_i and E_j are the linguistic label input, U_p , U_I , and U_D are the linguistic label output. Tables (1), (2), and (3) show the control rules that used for fuzzy self tuning of PID controller [7].

Table 1: Rule bases for determining the gain K_{p1} .

/e	NB	NS	ZE	PS	PB
NB	VB	VB	VB	VB	VB
NS	B	B	B	MB	VB
ZE	ZE	ZE	MS	S	S
PS	B	B	B	MB	VB
PB	VB	VB	VB	VB	VB

Table 2: Rule bases for determining the gain K_{i1} .

/e	NB	NS	ZE	PS	PB
----	----	----	----	----	----

NB	M	M	M	M	M
NS	S	S	S	S	S
ZE	MS	MS	ZE	MS	MS
PS	S	S	S	S	S
PB	M	M	M	M	M

Table 3: Rule bases for determining the gain K_{D1} .

/e	NB	NS	ZE	PS	PB
NB	ZE	S	M	MB	VB
NS	S	B	MB	VB	VB
ZE	M	MB	MB	VB	VB
PS	B	VB	VB	VB	VB
PB	VB	VB	VB	VB	VB

3) Defuzzification: This yields a non fuzzy control action from inferred fuzzy control action. The most popular method, center of gravity or center of area is used

$$u(nT) = \frac{\sum_{j=1}^n u(u_j) u_j}{\sum_{j=1}^n u(u_j)} \quad (7)$$

for defuzzification [8]:

Where $u(u_j)$ member ship grad of the element u_j , $u(nT)$ is the fuzzy control output, n is the number of discrete values on the universe of discourse.

3. Chopper Fed-DC Motor Drive

A DC motor consists of stator and armature winding in the rotor as in fig.5. The armature winding is supplied with a DC voltage that causes a DC current to flow in

the winding. This kind of machines are preferred over AC machines in high power application, because of the ease control of the speed and the direction of rotation of large DC-motor. The field circuit of the motor is exciting by a constant source. The steady state speed of the motor can be described as: [9, 10]

$$\omega = \frac{V_a - I_a R_a}{K_b} \quad (8)$$

Where K_b (is the back emf constant), R_a (armature resistance), I_a, V_a (armature current & voltage respectively), and ω (angular velocity).

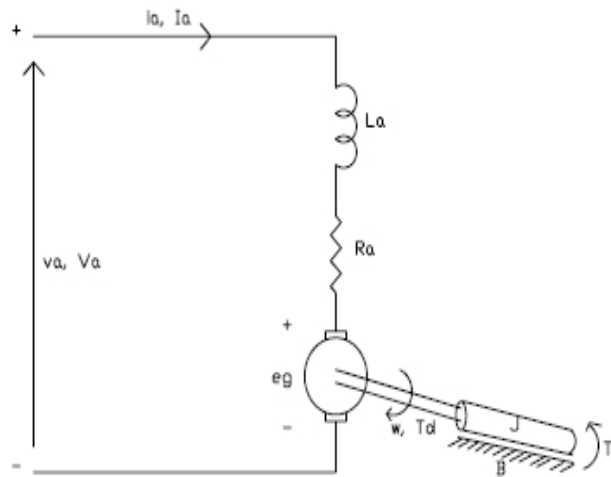

Fig.6: Permanent magnet DC motor.

The speed of a DC motor can be controlled by varying the voltage applied to the terminal. These can be done by using a pulse-width modulation (PWM) technique as shown in fig.6, where T is the signal period, t_d is the pulse-width, and V_m is the signal amplitude. A filed voltage signal with varying pulse-width is applied to the motor terminal. The average voltage is calculated from: [11, 12]

$$V_{ag} = \frac{1}{T} \int_0^T V(t) dt = \frac{t_d}{T} V_m = K V_m \quad (9)$$

Where K is the duty cycle, it can be mentioned from these equation that the average DC component of the voltage signal is linearly related to the pulse-width of the signal, or the duty cycle of the signal, since the period is fixed.

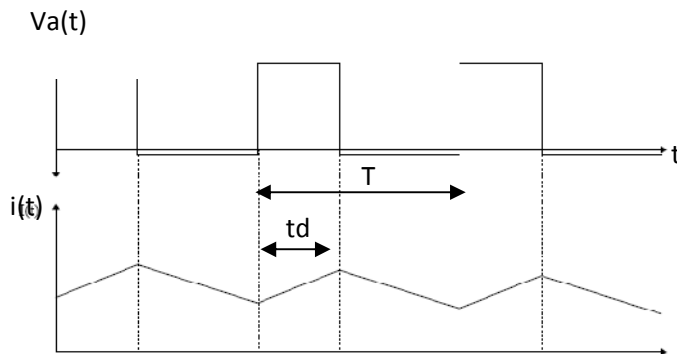

Fig.7: Pulse width modulation.

The PWM voltage waveform for the motor is to be obtained by using a special power electronic circuit called a DC chopper. The action of DC chopper is applying a train of unidirectional voltage pulses to the armature winding of the PM-DC motor as shown on fig.7. If t_d is varied keeping T constant, the resultant voltage wave represents a form of pulse width modulation, and hence the chopper is named as the PWM chopper [9, 12].

3.1 Circuit Description of Chopper Fed-DC Motor Drive

The block diagram shown in fig.8 a chopper fed- DC motor drive in the MATLAB simulation. A DC motor is fed by a DC source through a chopper which consists of GTO thyristor and a free-wheeling diode. The GTO and diode are simulated with the universal bridge block where the number of arms has been set to 1 and the specified power electronic device is GTO/Diode. Each switch on the block icon represents a GTO/antiparallel diode pair. Pulses are sent to the top GTO1 only. No pulses are sent to the bottom GTO2. Therefore Diode2 will act as a free wheeling diode.

The advantage of using the universal bridge block is that it can be discretized and allows faster simulation speeds than with an individual GTO and Diode. Also, when a purely resistive snubber is used, the commutation from GTO to Diode is instantaneous and cleaner wave shapes is obtained for voltage V_a . The motor drives a mechanical load characterized by inertia J , friction coefficient B , and load torque T_L .

The motor uses the discrete DC machine provided in the Extras/Additional machines library. The hysteresis current controller compares the sensed current with the reference and generates the trigger signal for the GTO thyristor to force the motor current to follow the reference. The speed control loop uses a proportional-integral controller which produces the reference for the current loop.

Current and voltage measurement blocks provide signals for visualization purpose [13].

3.2 Demonstration of Chopper Fed-DC Motor Drive

Start the simulation and observe the motor voltage (V_a), current (I_a) and speed (ω_m) on the scope. The following observations can be made:

1- $0 < t < 0.8$ s: Starting and Steady State Operation:

During this period, the load torque is $T_L = 5$ N.m and the motor reaches the reference speed ($\omega_{ref} = 120$ rad/s) given to the speed controller. The initial values of reference torque and speed are set in the two Step blocks connected to the T_L torque input of the motor. Notice that during the motor starting the current is maintained to 30 A, according to the current limit set in the speed regulator. Zoom in the motor current I_a in steady state. Observe the current triangular wave shape varying between 5 A and 7 A, corresponding to the specified hysteresis of 2 A. The commutation frequency is approximately 1.5 kHz.

2- $t = 0.8$ s: Reference Speed Step:

The reference speed is increased from 120 rad/s to 160 rad/s. The speed controller regulates the speed in approximately 0.25 s and the average current stabilizes at 6.6 A. During the transient period, current is still maintained at 30 A.

3- $t = 1.5$ s: Load Torque Step:

The load torque is suddenly increased from 5 N.m to 25 N.m. The current increases to 23 A, while the speed is maintained at the 160 rad/s set point [13].

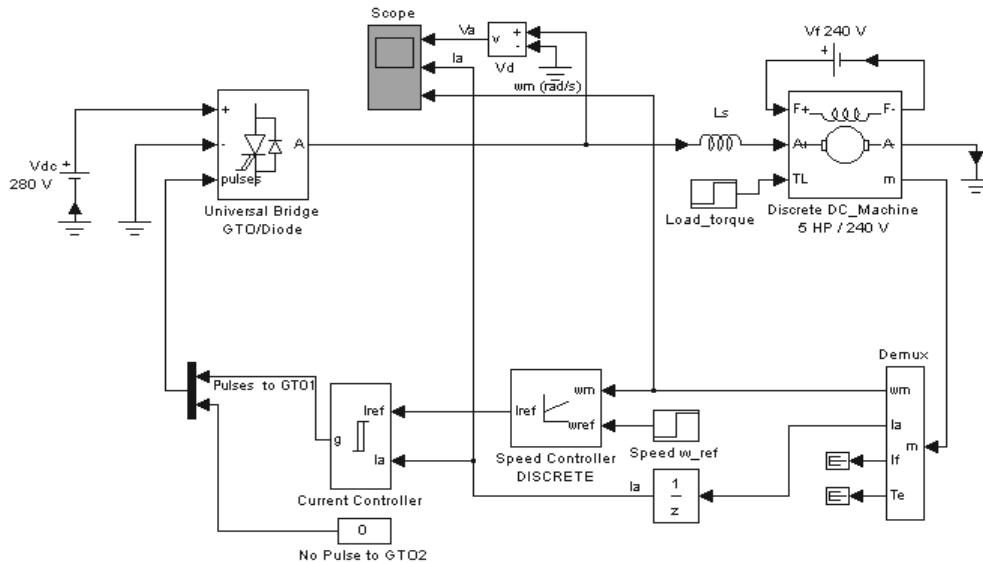

Fig.8: Simulation diagram for chopper fed-DC motor drive (Discrete).

4. Simulation and Results

The Fuzzy self tuning of a PID controller shown in fig.2 was designed and simulated for chopper fed-DC motor drive. The example Chosen here for simulation and comparison are taken from [13], where they were simulated and compared to the conventional PID controller. Next step is to replace the conventional PI controller (speed controller) by fuzzy self tuning of PID controller. By tuning the gains of the conventional PID controller and producing the optimum response using trial and error method, the simulation start with the best initial gains as the following: $K_p = 25$, $K_i = 0.75$, $K_d = 0.5$ and the scaling gain $K_e = 0.01$, $K_e = 0.05$.

The comparisons between the conventional and fuzzy self tuning of PID controller are shown in the figs. (9.a, 9.b, 9.c) and figs. (10.a, 10.b, 10.c).

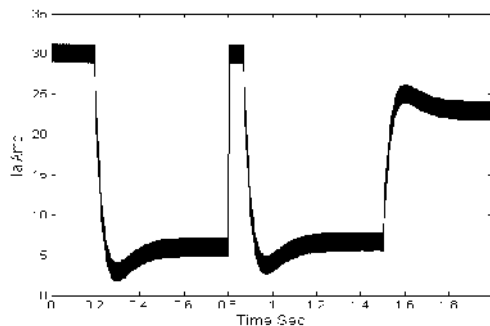

Fig.9.a: Motor current (I_a) using conventional PID controller.

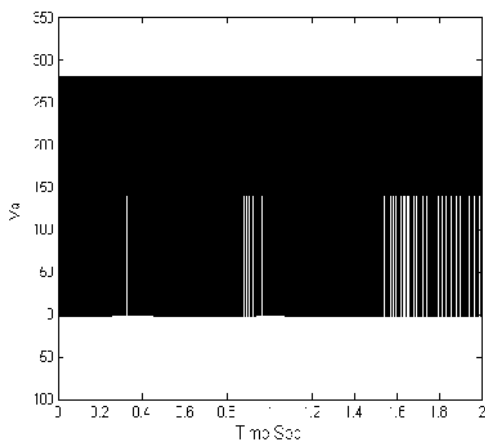

Fig.9.b: Motor voltage (V_a) using conventional PID controller.

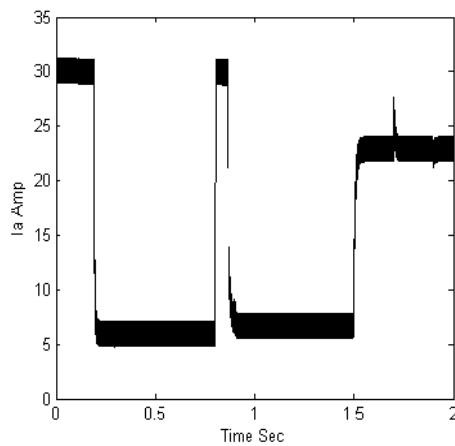

Fig.10.a: Motor current (I_a) using FPID self tuning controller.

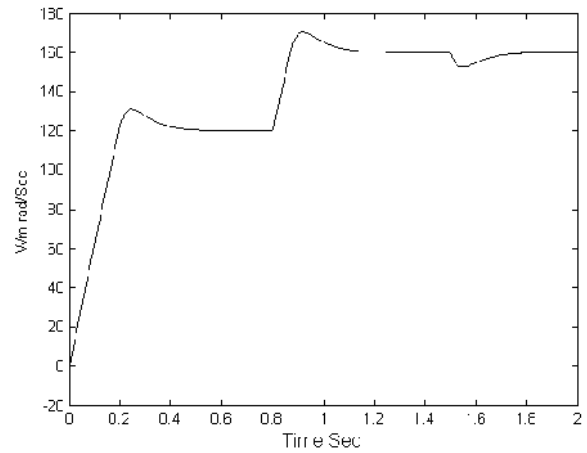

Fig.9.c: Motor speed (ω_m) using conventional PID controller.

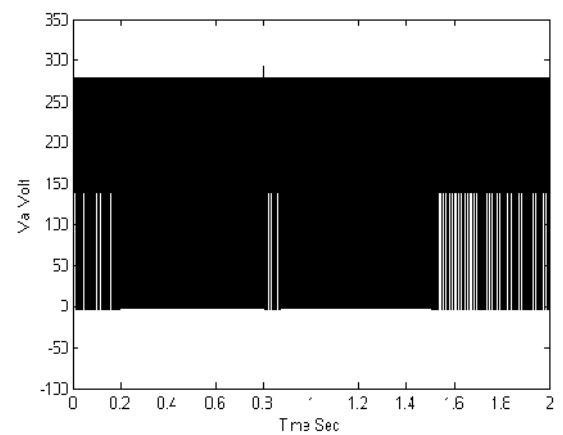

Fig.10.b: Motor voltage (V_a) using FPID self tuning controller.

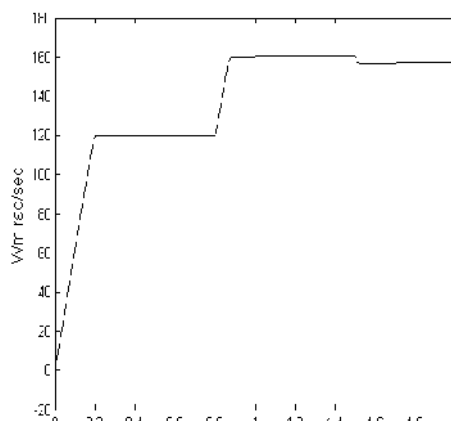

Fig.10.c: Motor speed (w_m) using
 FPID
 self tuning controller.

Figs. (11, 12, and 13) shows how the proportional, integral and derivate (K_{P1} , K_{I1} , K_{D1}) gains vary online with the output of the system under control. Figs. (14, 15, and 16) shows the rule surface viewer of the K_{P1} , K_{I1} , and K_{D1} respectively.

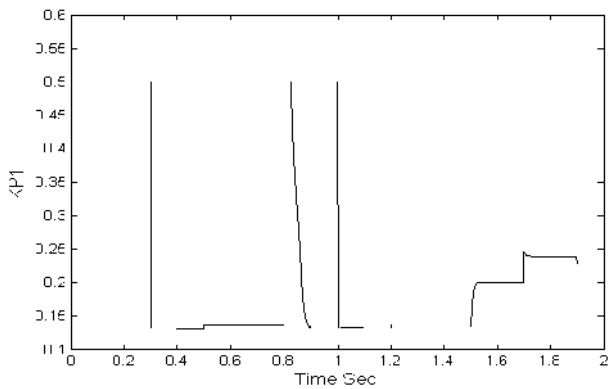

Fig.11: gain (K_{P1}) varies online with the output of the system under control.

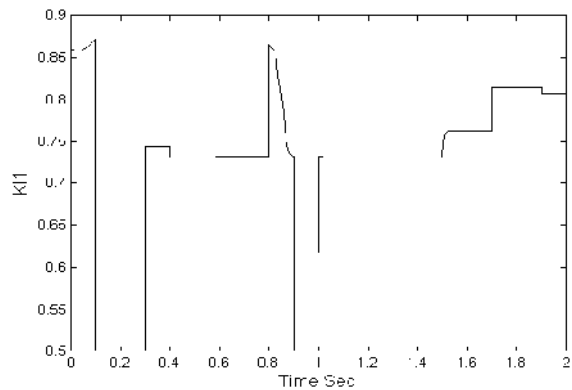

Fig.12: gain (K_{I1}) varies online with the output of the system under control.

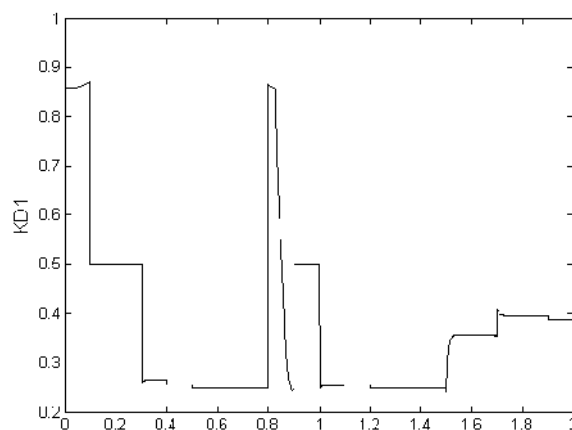

Fig.13: gain (K_{D1}) varies online with the output of the system under control.

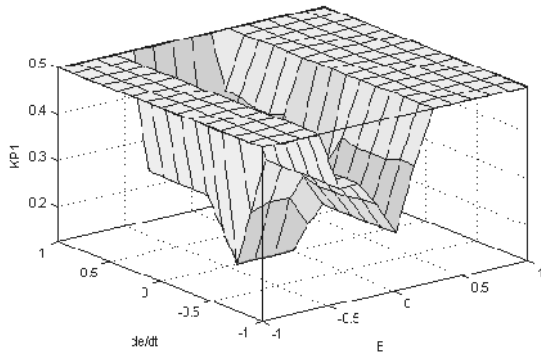

Fig.14: Rule surface viewer of K_{P1} .

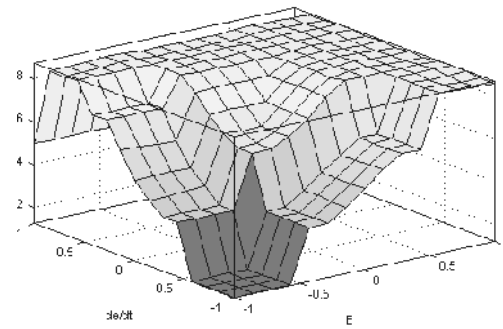

Fig.15: Rule surface viewer of K_{D1} .

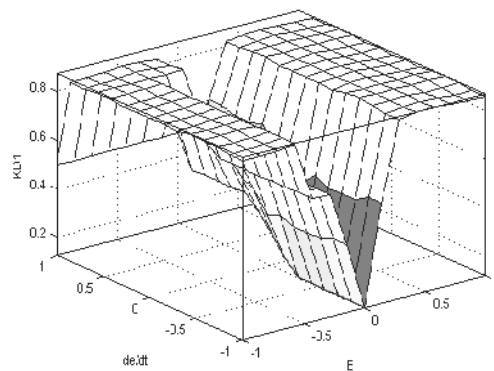
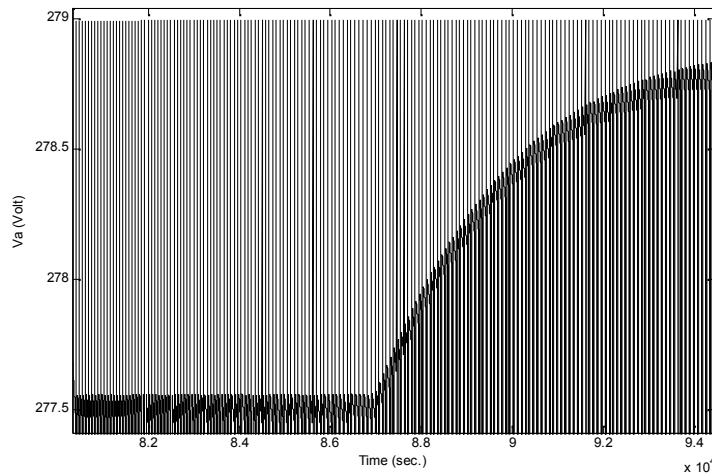

Fig.16: Rule surface viewer of K_{D1} .

Fig. 17 show the time zooming section for the motor voltage (V_a), Figs. (9.b, and 10.b).



Conclusions

Fig.17: Motor voltage (V_a) After Zooming.

Two inputs- three outputs self tuning of a PID controller are designed and used for implementing a chopper fed-DC motor drive. The controller is combining the fuzzy technique with the PID technique to compose the fuzzy self-tuning of a PID controller. The fuzzy part can be adjusting the three parameters of PID controller on-line according to the change of e and \dot{e} . It is concluded that the fuzzy self tuning controller as compared with the conventional PID controller, it provides improvement performance in both transient and the steady states response, fuzzy self tuning has no overshoot and has a smaller steady state error compared to the conventional PID controller. It can be mentioned here that this controller is able to stack at the stable region with rigid performance on tracking the reference signal without need to exceed the accepted safety limitation range of the DC motor performance , as armature current (I_a) and armature voltage (V_a) that shown in figures 10.a and 10.b. One can also see in figures 9.b and 10.b that the maximum overshoot of the stream pulses that represents armature voltage (V_a) didn't exceed 279Volt. The simulation results show that fuzzy self tuning of a PID controller has fairly similar characteristics to its conventional counterpart and provides good performance.

Reference

- [1]: H.X.Li and S.K.Tso, "Quantitative design and analysis of Fuzzy Proportional-Integral-Derivative Control- a Step Towards Autotuning", International journal of system science, Vol.31, No.5, 2000, pp.545-553.
- [2]: Thana Pattaradej, Guanrong Chen and Pitikhate Sooraksa, "Design and Implementation of Fuzzy P²ID Control of a bicycle robot", Integrated computer-aided engineering, Vol.9, No.4, 2002.
- [3]: Weiming Tang, Guanrong Chen and Rongde Lu, "A Modified Fuzzy PI Controller for a Flexible-joint Robot Arm With Uncertainties", Fuzzy Setd and System, 118 (2001) 109-119.
- [4]: Leronid Reznik, Omar Ghanayem, anna bourmistrov, "PID Pulse Fuzzy Controller Structures as a Design for Industrial Application", Engineering application of artificial intelligence, Vol.13, No.4, 2002, pp.419-430.
- [5]: Keven M.Passino and Stephen Yurkovich, "Fuzzy Control", Addison Wesley longnan, Inc., 1998.
- [6]: Katsuhiko ogata, "Modern Control Engineering", Prentic-hall, Inc., 2002.
- [7]: G.R.Chen and T.T.Pham, "Introduction to fuzzy sets, fuzzy logic, fuzzy control system", CRC.Press, Boac Raton, FL, USA, 2000.
- [8]: Michall Petrov, Ivan Ganchev and Ivan dragotinov, "Design Aspects of Fuzzy PID Control", International conference on soft computing, Mendel "99", Brno, czech republic, 9-12, jun.1999, pp.277-282.
- [9]: M.H.Rashid, "Power Electronics", Prentic-Hall of India, Newdelhi, 1994.
- [10]: A.S.Poznyak, "Adaptive Tracking for DC-Derivative Motor Based on Motions Forgetting", Computation system, Vol.4, No.3, 2001, pp.205-212.
- [11]: B.C.Kou, "Automatic Control Systems", Prentic-Hall, Inc., 1987.
- [12]: "DC Motor Drive", Digital Signal Processing Control of Electric Machines and Drives Laboratory, Lab6, department of electrical and computer engineering, the ohio state university, www.ece.osu.edu/ems/ee647/Lab-manual/Lab6.pdf.
- [13]: H.Lehuy and G.sybille, MATLAB Help ver.7, Math works, Inc., 2004

