

## Implementation Of The SPWM Technique For Harmonic Elimination Using Microcontroller

Kamil G. Salih / University of Mosul / College of Agriculture & Forestry /  
Basic Science Department

### Abstract

Elimination of load harmonics can be achieved by either filtration of selected harmonics or the use of pulse-width modulation PWM technique. Many PWM techniques are developed, but the most commonly used in industrial applications is the SPWM technique where the distortion factor DF (one of the most important performance parameters of the quality and efficiency of a lot of the electronic devices) is significantly reduced. In this paper, the SPWM technique for harmonic elimination (HE) is implemented using 8051 microcontroller and the well known MATLAB software. The result is tested on a prototype inverter which was designed since 1998. This method is based on the analysis of Fourier series and Fourier coefficients of the required SPWM output voltage waveform.

In this paper, the odd function technique with three and five pulses per half cycle to generate the required SPWM control signals is achieved. The basic flow chart of the control program, samples of the experimental results as well as an appendix illustrating the complete source code programs (INV1) and (INV2) in an assembly language of 8051 microcontroller are given.

Key words : Harmonics elimination, PWM, Microcontroller, Inverter .

### تنفيذ تقنية SPWM لحذف التوافقيات باستخدام المسيطر المصغر

كامل غاوي صالح / جامعة الموصل / كلية الزراعة والغابات / قسم العلوم الأساسية

#### الخلاصة

يتحقق حذف التوافقيات للحمل الكهربائي إما بواسطة المرشحات الالكترونية أو باستخدام تقنية تضمين عرض الموجة PWM. هنالك عدة تقنيات لتضمين عرض الموجة بيد أن الأكثر شيوعاً واستخداماً في التطبيقات الصناعية هي تقنية SPWM حيث يقل عامل الضوضاء (DF) (الذي يعتبر من أهم العوامل التي تحدد كفاءة وجوده كثير من الأجهزة الالكترونية) فيها بشكل كبير. تم في هذا البحث تنفيذ الطريقة الأكثر شيوعاً لحذف التوافقيات باستخدام المسيطر المصغر (8051) ونظام الرياضيات المعروف (MATLAB) وفحص أداء هذه الطريقة على أنموذج للعاكسة الالكترونية التي تم تصنيعها منذ عام 1998. تعتمد هذه الطريقة على التحليل الرياضي وذلك بإيجاد متوالية Fourier وحساب المعاملات الخاصة بها لموجة فولتية الإخراج المطلوبة. تم في هذا البحث تحقيق تقنية (Odd function) لثلاث وخمس نبضات في نصف دورة لتوليد إشارات التضمين والتحكم اللازمة (SPWM). وأخيراً جرى عرض المخطط الانسيابي الأساسي لبرنامج التحكم ونماذج من النتائج المختبرية إضافة إلى ملحق يوضح تفصيلاً برنامجي الأساس (INV1&INV2) بلغة التجميع للمسيطر المصغر 8051.

## INTRODUCTION:

In this section, a brief summary of power inverters is presented. Dc-to-ac converters are known as inverters. The function of an inverter is to change dc input voltage to ac output voltage with the desired frequency and magnitude. A static semiconductor circuit of an inverter does this electrical energy transformation. This type of inverter is called voltage-source inverter (VSI) in which dc input voltage (battery voltage) is constant and independent of the load current drawn. The inverter specifies load voltage while the load dictates the shape of the drawn current [1].

The output waveforms (voltage or current) of an inverter are usually rectilinear in nature and as such contain harmonics which will reduce the efficiency and performance of the load. Elimination of load harmonics can be achieved by either filtration of selected harmonics or using pulse-width modulation PWM technique.

The efficiency and quality of an inverter output is normally evaluated in terms of the following performance parameters [2]:

**Harmonic factor (HF<sub>n</sub>)**: The harmonic factor (of the nth harmonic), a measure of the individual harmonic contribution, is defined as

$$HF_n = V_{on} / V_{01} \quad \text{for } n > 1 \quad \text{----- (1)}$$

where  $V_{01}$  is the rms value of the fundamental component and  $V_{on}$  is the rms value of the nth harmonic component.

**Total harmonic distortion (THD)**: The total harmonic distortion, a measure of closeness in shape between the fundamental component and the actual waveform, is defined as

$$THD = \left( \sum_{n=2,3,\dots}^{\infty} V_{on}^2 \right)^{1/2} / V_{01} \quad \text{----- (2)}$$

**Distortion factor (DF)**: The distortion factor indicates the amount of harmonic distortion that remains in a particular waveform after the harmonics of that waveform subjected to a second-order attenuation is divided by  $n^2$ . Thus distortion factor is a measure of effectiveness in reduction unwanted harmonics without having to specify values of a second-order filter and is defined as

$$DF = \left[ \sum_{n=2,3,\dots}^{\infty} \left( V_{on} / n^2 \right)^2 \right]^{1/2} / V_{01} \quad \text{----- (3)}$$

## Sinusoidal Pulse–Width Modulation SPWM Technique (SPWM):

The basic method of obtaining SPWM is demonstrated by many references but the most preferable one is presented by Mohammad H. Rashid [2] in which the width of each pulse varies in proportion to the amplitude of the sine wave evaluated at the center of the same pulse as shown in figure (1). In this technique, the control signals are generated by comparison between the triangular carrier wave of frequency  $f_c$  and a sinusoidal reference signal  $f_r$ . This technique is commonly used in industrial applications. The frequency  $f_r$  of the reference signal determines the frequency  $f_o$  of the output inverter;  $A_r$  the peak amplitude controls the modulation index  $M(M=A_r/A_c)$  which intern controls the rms output voltage  $V_o$ . Comparison of the carrier signal  $V_{cr}$  with the two sinusoidal reference signals ( $V_r$  &  $-V_r$ ) shown in figure (1a) gives the control signals  $g_1$  &  $g_4$ , respectively as indicated in figure (1b).

This can be implemented by an analogue circuit using op-amp as a comparator. The output voltage waveform is obtained from  $V_o = V_s(g_1 - g_4)$ .

The carrier frequency determines the number of pulses per half cycle as :

$$f_{cr} / f_r = \text{number of pulses} \quad \text{----- ( 4 )}$$

The modulation index (M) controls the rms output voltage. From the figure, it can be seen that the area of each pulse corresponds approximately to the area under the sine wave between adjacent midpoints of off periods on the gating signals [2].

If  $\delta_m$  defines the width of mth pulse, the rms output voltage can be calculated from the following equation

$$V_o = V_s \left( \sum_{m=1}^{2N} \delta_m / \pi \right)^{1/2} \quad \text{----- (5)}$$

where N defines the number of pulses per half-cycle.

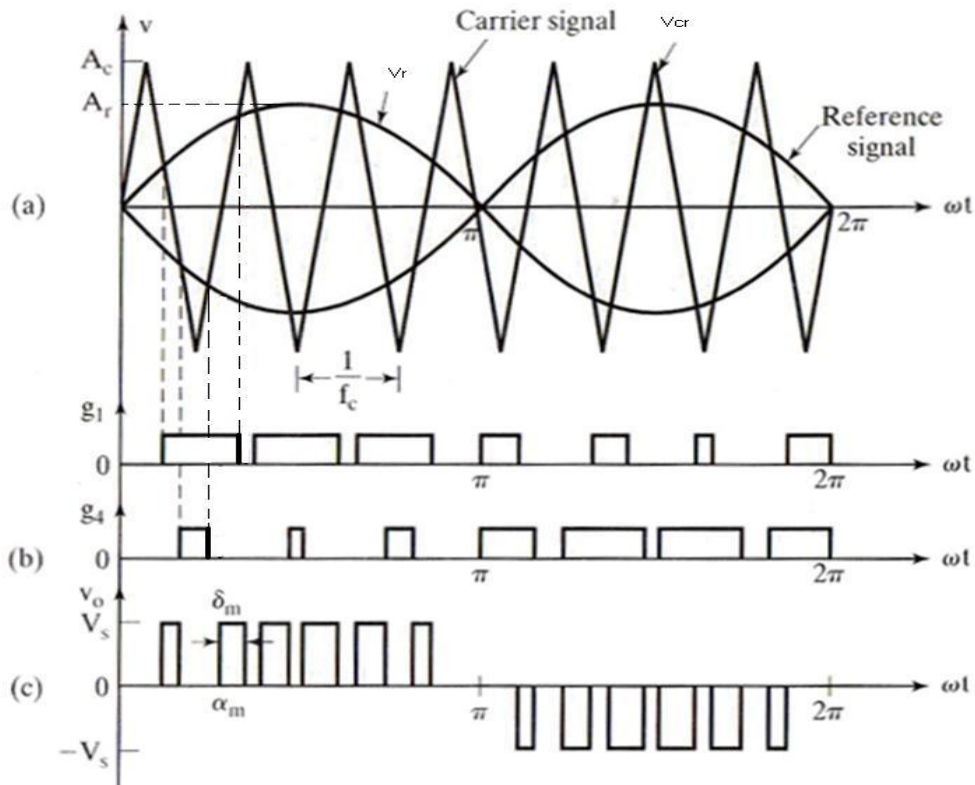

**Fig. 1 : Sinusoidal Pulse-Width Modulation SPWM**

The Fourier series of the instantaneous output voltage in general form is :

$$V_o(t) = a_0 + \sum_{n=1}^{\infty} [ a_n \cos(n\omega t) + b_n \sin(n\omega t) ] \quad \text{----- (6)}$$

The even harmonics ( $n=2,4,6,\dots$ ) are cancelled because of the symmetry of the output voltage along the x-axis since  $a_0=0$  &  $a_n=0$ , hence the instantaneous output voltage is reduced to [3]

$$V_o(t) = \sum_{n=1,3,5,\dots}^{\infty} b_n \sin(n\omega t) \quad \text{-----(7)}$$

The Fourier coefficient of output voltage can be found as :

$$b_n = \sum_{m=1}^{2N} 4V_s/n\pi \sin(n\delta_m/4) [ \sin(\alpha_m+3\delta_m/4) - \sin n(\pi+\alpha_m+\delta_m/4) ] \quad \text{-----(8)}$$

for n=1,3,5,..

The width of the pulses and the harmonic profile of sinusoidal modulation can be evaluated by a computer program. Figure 2 indicates the harmonic profile for five pulses per half cycle (N=5) . It can be seen that the distortion factor (DF) is significantly reduced in comparison with the other PWM techniques (single or multiple-pulse-width modulation techniques). All harmonics less than or equal to (2N-1) are eliminated by this type of modulation. For N=5, the lowest order harmonic (LOH) is the ninth[2].

**Fig. 2 : Harmonic Profile Of SPWM**

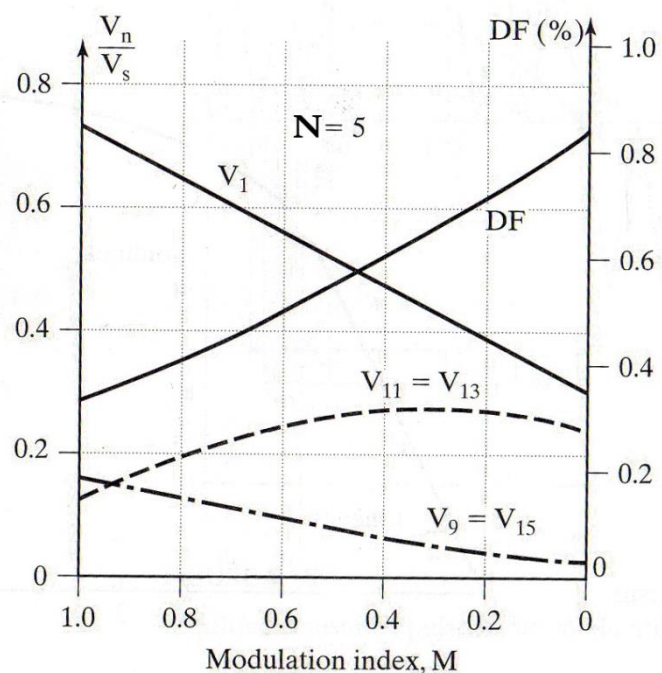

### The Most Common Harmonic Elimination Method :

Many methods of (HE) are developed[4], but the most common used one satisfies the following techniques:

- Optimized PWM switching strategies ( OPWM ).
- Harmonic elimination PWM technique ( HEPWM ).
- Programmed PWM techniques.

In this method a large number of OPWM switching angles are usually programmed off-line into an EPROM or a microcontroller's data memory. The Two commonly used SPWM techniques are; the odd function technique which applies odd number of pulses per half cycle(3,5,7,...) while the even function technique uses an even number of pulses per half cycle in the inverter output waveform . Odd function technique is more preferable and usable than the even one since it represents the sine wave signal more closely (better curve fitting). Therefore it is used in this work.

Applying this technique to obtain the required switching angles needs the adoption of the following steps:

**Step1 :** Selection of a particular performance method which eliminates several lower-order harmonics from the inverter output with the specification of odd or even function SPWM technique and determination of number the of pulses per half cycle to be used.

**Step2 :** Plotting the required generalized quarter-wave symmetric PWM inverter output voltage waveform.

**Step3 :** Calculation of Fourier coefficients of the generalized SPWM waveform in terms of N variables ( N:number of switching angles per quarter cycle (Notches)), taking into consideration that the number of switching angles per quarter cycle is equal to the number of pulses per half cycle.

**Step4 :** Computation of switching angles by equating of N-1 harmonics to zero and assignment of specific value of amplitude of the fundamental of inverter output voltage in per unit value (M). A set of non-linear equations to be developed with multiple solutions for switching angles satisfying the criterion:

$$\alpha_1 < \alpha_2 < \alpha_3 < \dots < \alpha_N < \pi/2 \text{ -----(9)}$$

Switching angles have to be obtained for each increment in M for voltage control with simultaneous elimination of harmonics . These non-linear equations have to be solved using suitable numerical method i.e. standard math library for PC environment (for example MATLAB).

**Step5 :** A program is written in an assembly language for the microcontroller used to generate the required SPWM waveform control signals after storing the required switching angles(degree values), obtained in the previous step into the data memory (look-up table) and converting them into time domain.

### **Implementation of the SPWM Technique for HE Using 8051 Microcontroller & MATLAB :**

This section explains the implementation of HE method based on MATLAB analysis that can be applied in microcontroller based system.

Two cases are studied. The first one is the odd function simulation technique of the sinusoidal waveform using three PWM pulses per half cycle (INV1), while the second one applies five PWM pulses per half cycle (INV2).

#### **CASE 1 [ ODD FUNCTION TECHNIQUE WITH 3 PULSES / HALF CYCLE ( INV1) ] :**

##### **STEP 1: Determination of HE method:**

Definition of HE criteria is achieved by following steps :

- Applying Odd function technique.
- Number of pulses is three per half cycle.
- Elimination of several lower-order harmonics from the inverter output can be calculated from the (2N-1) formula. Hence for N=3, the lowest order harmonic (LOH) is the fifth. All harmonics less than 5<sup>th</sup> are eliminated [2].

##### **STEP 2: Plotting The Required SPWM Inverter Output Waveform :**

Figure(3) indicates the required inverter sinusoidal output waveform and its corresponding SPWM waveform with 3 pulses per half cycle.

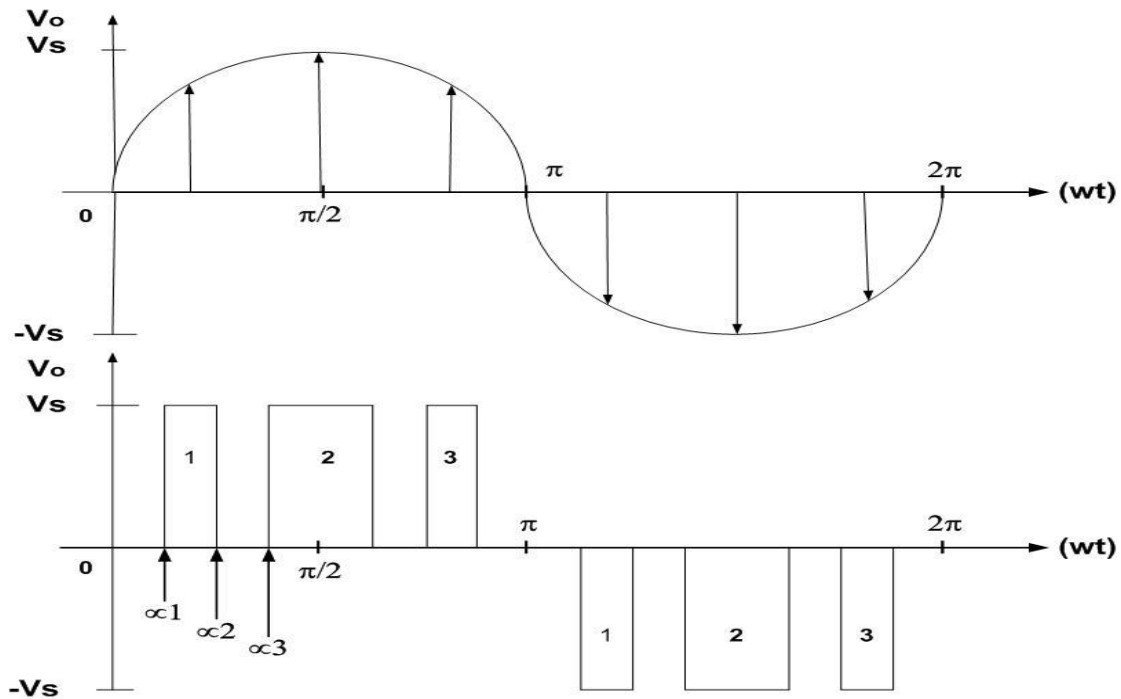

Fig. (3) : Required SPWM Inverter Output Waveform for N=3

**STEP 3 : Calculation of Fourier Coefficients of The SPWM Waveform :**

Figure (3) indicates that SPWM is a quad-wave symmetry waveform. In general this type of waveforms has the following mathematical Fourier series and coefficients [3] :

$$F(x) = \sum_{n=1,3,5,\dots}^{\infty} b_n \sin(nx) \quad \text{-----(10)}$$

$$a_0 = a_n = 0 \quad , \quad b_n = \frac{2}{\pi} \int_0^{\pi} f(x) \sin(nx) \, dx \quad n=1,3,5,\dots \quad \text{-----(11)}$$

$$b_n = \frac{4}{\pi} \int_0^{\pi/2} f(x) \sin(nx) \, dx \quad \text{-----(12)}$$

$$b_n = \frac{4}{\pi} \left[ \int_{\alpha_1}^{\alpha_2} f(x) \sin(nx) \, dx + \left[ \int_{\alpha_3}^{\pi/2} f(x) \sin(nx) \, dx \right] \right] \quad \text{-----(13)}$$

The above equation can be simplified to the following generalized equation :

$$b_n = \frac{4V_s}{n\pi} \left[ \sum_{K=1}^N (-1)^{k+1} \cos(n\alpha_k) \right] \quad n=1,3,5,\dots \quad \text{-----(14)}$$

Where N as previously defined equals the number of pulses per half cycle.

**STEP 4 : Switching Angles or Notches Calculation :**

From equation (14), one can derive the mathematical equations for the fundamental, 3<sup>rd</sup> and 5<sup>th</sup> harmonic components as :

$$b_1 = \frac{4V_s}{\pi} \left[ \cos(\alpha_1) - \cos(\alpha_2) + \cos(\alpha_3) \right] \quad \text{-----(15)}$$

$$b_3 = \frac{4V_s}{3\pi} \left[ \cos(3\alpha_1) - \cos(3\alpha_2) + \cos(3\alpha_3) \right] \quad \text{-----(16)}$$

$$b_5 = 4V_s/5\pi [ \cos(5\alpha_1) -\cos(5\alpha_2) +\cos(5\alpha_3) ] \quad \text{-----(17)}$$

For N=3 pulses, equating (N-1) harmonics=0 gives the 3<sup>rd</sup> and 5<sup>th</sup> harmonics=0 as:

$$\cos(\alpha_1) -\cos(\alpha_2) +\cos(\alpha_3) = \pi/4 b_1 \quad \text{-----(18)}$$

$$\cos(3\alpha_1) -\cos(3\alpha_2) +\cos(3\alpha_3) =0 \quad \text{-----(19)}$$

$$\cos(5\alpha_1) -\cos(5\alpha_2) +\cos(5\alpha_3) =0 \quad \text{-----(20)}$$

MATLAB is used to solve these three non-linear equations to find ( $\alpha_1, \alpha_2, \alpha_3$ ) for different values of b1(1,0.9,0.8,.....,0.1) respectively knowing that b1=M.

In MATLAB, Levenberg-marquardt algorithm was used instead of trust-region dogleg algorithm which is the weighted average of Newton's method and steepest Descent method. Since the steepest Descent method is a good way to obtain the initial condition compared to Newton's method, the weight is biased toward the steepest method until convergence is detected, at which time the weight is shifted toward the more rapidly convergent Newton's method[5].

Table (1) indicates switching angles ( $\alpha_1, \alpha_2, \alpha_3$ ) obtained for M=1,0.9,0.8,.....,0.1 respectively, while figure (4) shows the plot of these switching angles.

|                                  |            | Modulation Index (M) |     |     |     |     |     |     |     |     |     |
|----------------------------------|------------|----------------------|-----|-----|-----|-----|-----|-----|-----|-----|-----|
|                                  |            | 1                    | 0.9 | 0.8 | 0.7 | 0.6 | 0.5 | 0.4 | 0.3 | 0.2 | 0.1 |
| Switching<br>Angles<br>( Degree) | $\alpha_1$ | 26                   | 29  | 31  | 33  | 35  | 37  | 38  | 40  | 42  | 43  |
|                                  | $\alpha_2$ | 47                   | 53  | 55  | 54  | 53  | 52  | 51  | 50  | 48  | 47  |
|                                  | $\alpha_3$ | 55                   | 64  | 69  | 73  | 76  | 78  | 81  | 83  | 85  | 88  |

**Table (1) : Switching Angles Solution**

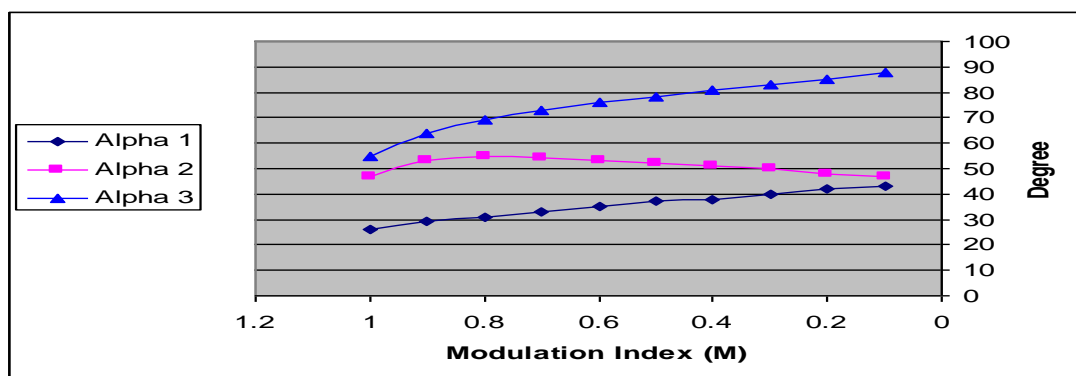

**Fig. (4) : Plot Of Switching Angles Solution**

**SEP 5 : Generation of SPWM Waveform Signals :**

The generation of SPWM waveform signals is performed by writing an assembly program (INV1) using assembly language of 8051 microcontroller [6].

The switching angles obtained from table (1) are stored into the data memory of 8051 microcontroller as a look-up table. The program uses one of the 16-bit timers (TR0) of such

microcontroller as a down counter to convert switching angles from degree values into time domain ( $\mu\text{s}$ ) as shown in figure (5). Two bits of the input/output port (P2.7 & P2.6) of the 8051 microcontroller are used to generate the required switching signals [7].

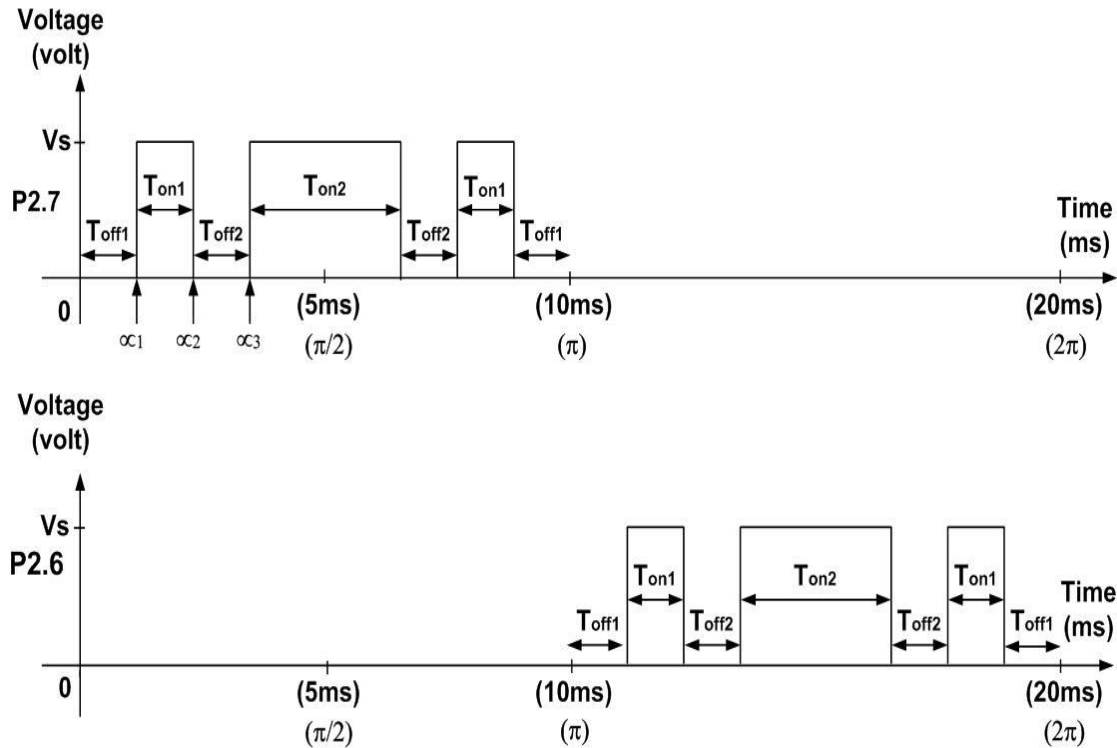

Fig. (5) : Required SPWM Waveform Signals

#### The Main Control Program :

The main control program is written to perform many tasks as illustrated in figure (6) which presents its detailed flow chart. A complete list of the source program (INV1) in an assembly language is presented in the appendix.

#### CASE 2 [ ODD FUNCTION TECHNIQUE WITH 5 PULSES / HALF CYCLE ( INV2 ) ] :

In this case, the same steps are repeated as done in the previous case. The only difference is using five clock pulses instead of three per half cycle as shown in figure (7). All switching angles values are given in table (2), while figure (8) shows the plot of these switching angles solution trajectories for  $N=5$ .

The complete list of source program (INV2) is also presented in the appendi



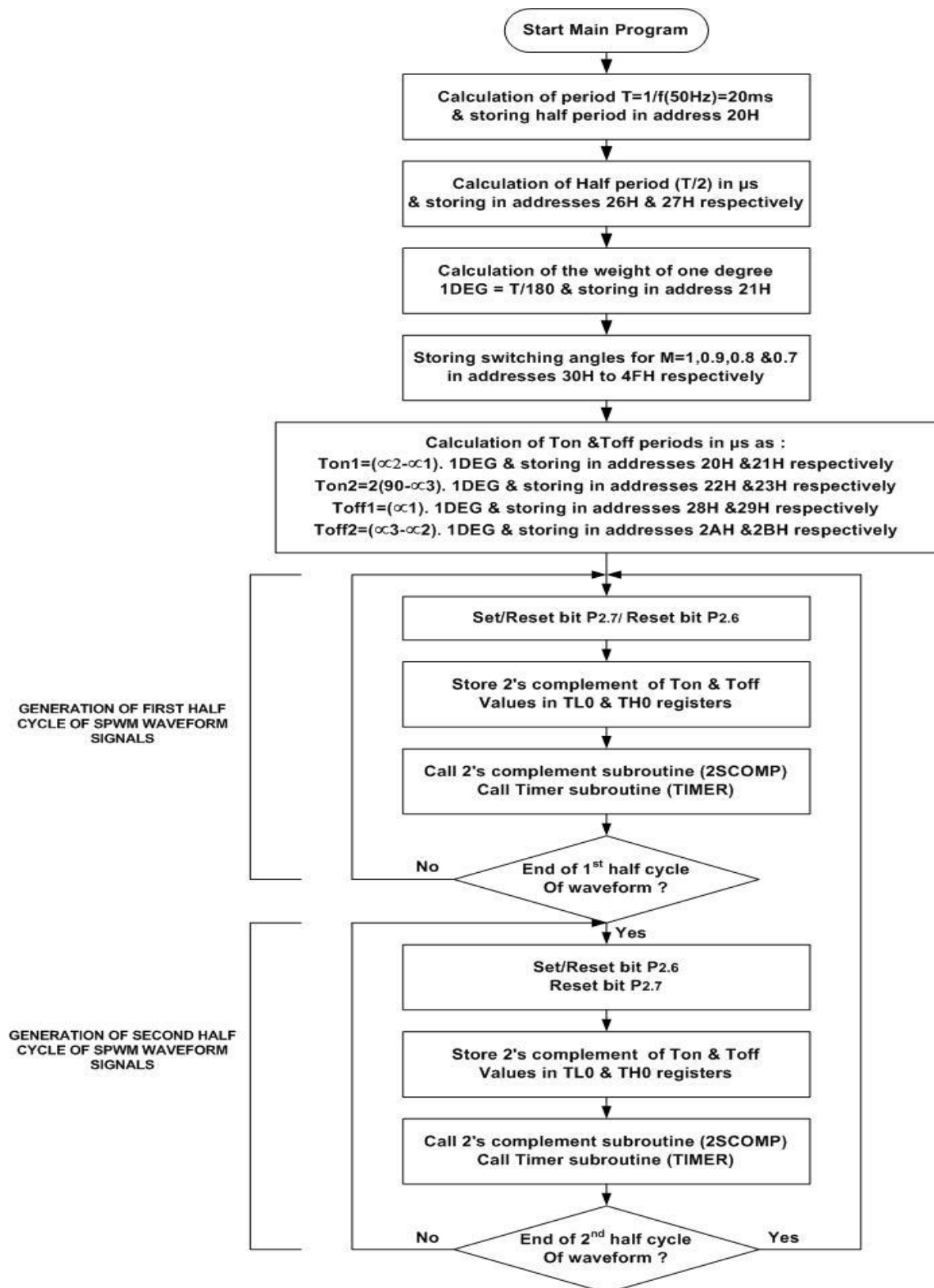

Fig. (6) : Detailed Flow Chart of the Main Control Program

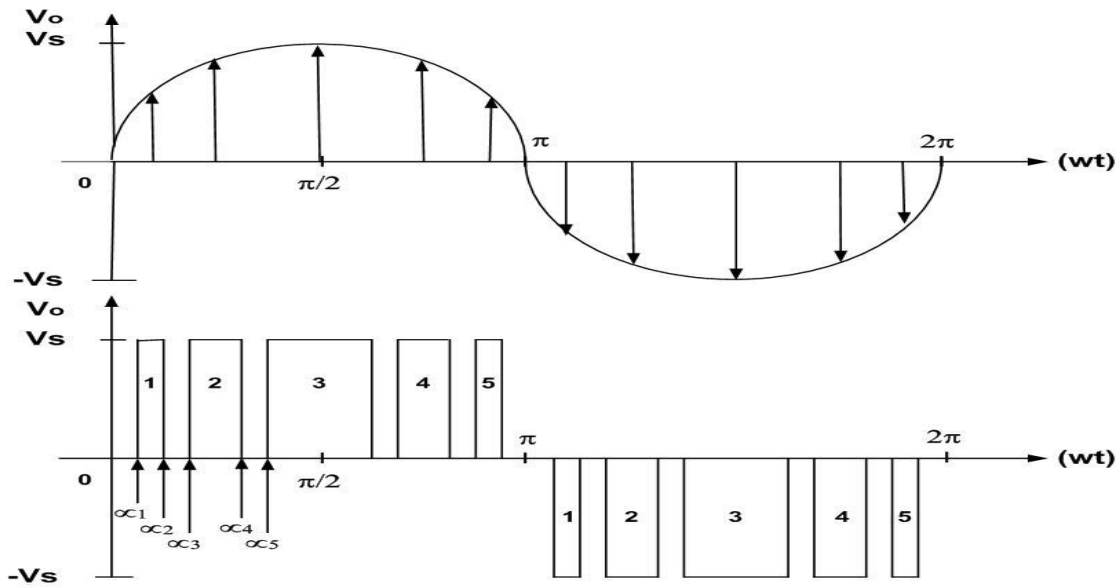

Fig. (7) : Required SPWM Inverter Output Waveform for N=5

|                                  |            | Modulation index(M) |     |     |     |     |     |     |     |     |     |
|----------------------------------|------------|---------------------|-----|-----|-----|-----|-----|-----|-----|-----|-----|
|                                  |            | 1                   | 0.9 | 0.8 | 0.7 | 0.6 | 0.5 | 0.4 | 0.3 | 0.2 | 0.1 |
| Switching<br>Angles<br>( Degree) | $\alpha_1$ | 20                  | 22  | 23  | 24  | 25  | 26  | 27  | 28  | 28  | 29  |
|                                  | $\alpha_2$ | 31                  | 33  | 34  | 34  | 34  | 33  | 33  | 32  | 31  | 31  |
|                                  | $\alpha_3$ | 42                  | 45  | 48  | 50  | 51  | 53  | 55  | 56  | 57  | 59  |
|                                  | $\alpha_4$ | 62                  | 68  | 69  | 68  | 67  | 66  | 65  | 64  | 63  | 61  |
|                                  | $\alpha_5$ | 64                  | 73  | 76  | 79  | 81  | 82  | 84  | 85  | 87  | 89  |

Table (2) : Switching Angles Solutions Trajectories

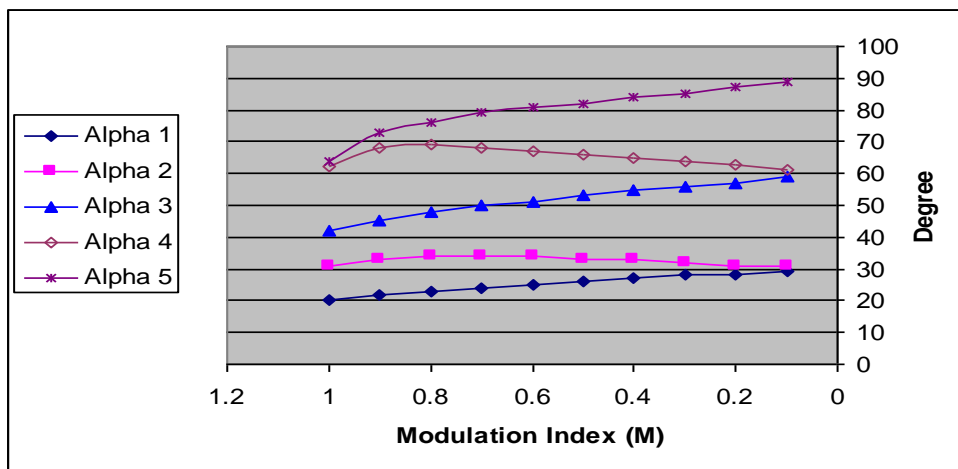

Fig. (8) : Plot of Switching Angles Solutions Trajectories

**Experimental Results and Discussion :**

To investigate the effect of HE method, two experimental setups were built; one for square wave output (without HE) and the other for HE :

**Case (1) : The Square wave control signal (SW) :**

Figure (9) shows the experimental setup which consists of a prototype inverter that has three basic parts; the first part is the oscillator circuit which produces two complementary switching signals (Q & Q̄) of frequency 50 Hz. The second part includes the driver and power transistors (used as electronic switches), while the third part is a step-up transformer to give the required ac output voltage. The real output power (P<sub>OUT</sub>) is measured by single-phase wattmeter while the (THD) parameter is measured by using Power Pad AEMC instruments (Model 3945-B).

The efficiency (γ) of the inverter is calculated from :

$$P_{IN} = V_{IN} * I_{IN} \text{ ----- ( 21 )}$$

Where V<sub>IN</sub> is measured by DC voltmeter connected across the battery terminals and I<sub>IN</sub> is measured by DC clamp meter.

$$\gamma = ( P_{OUT} / P_{IN} ) * 100 \% \text{ -----( 22 )}$$

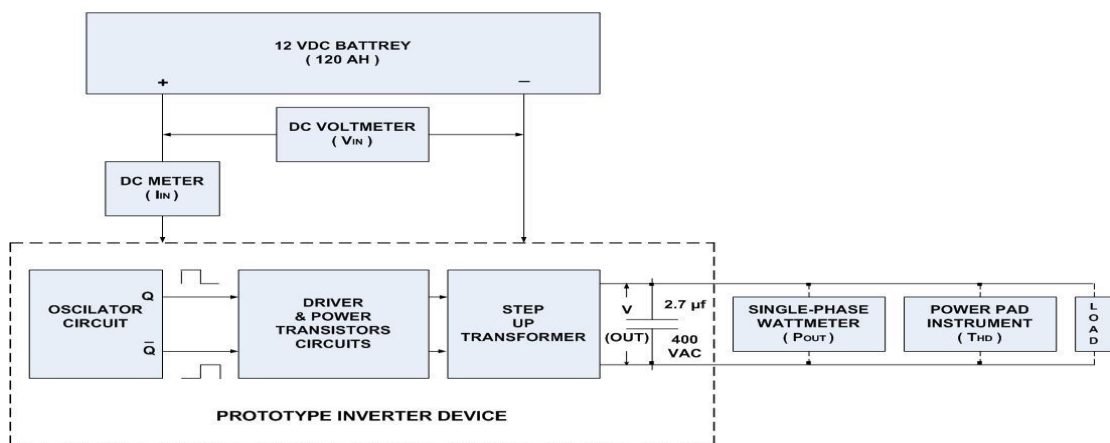

**Fig. ( 9 ) : Square Wave Control Signal ( SW ) Setup**

**Case (2) : The SPWM Control Signals (INV1& INV2) :**

In this case, the oscillator circuit as shown in figure (10) is replaced by Microcontroller Training System (MTS-51) to produce the two complementary switching signals (P<sub>2.7</sub>& P<sub>2.6</sub>). Two programmed 8051 microcontroller chips are needed for (INV1& INV2) control programs. Actually, the output port of the microcontroller is protected from driver and power transistors circuits by triple logic inverters (for each bit) which act as a buffer circuit as well as driving the required TTL output current.

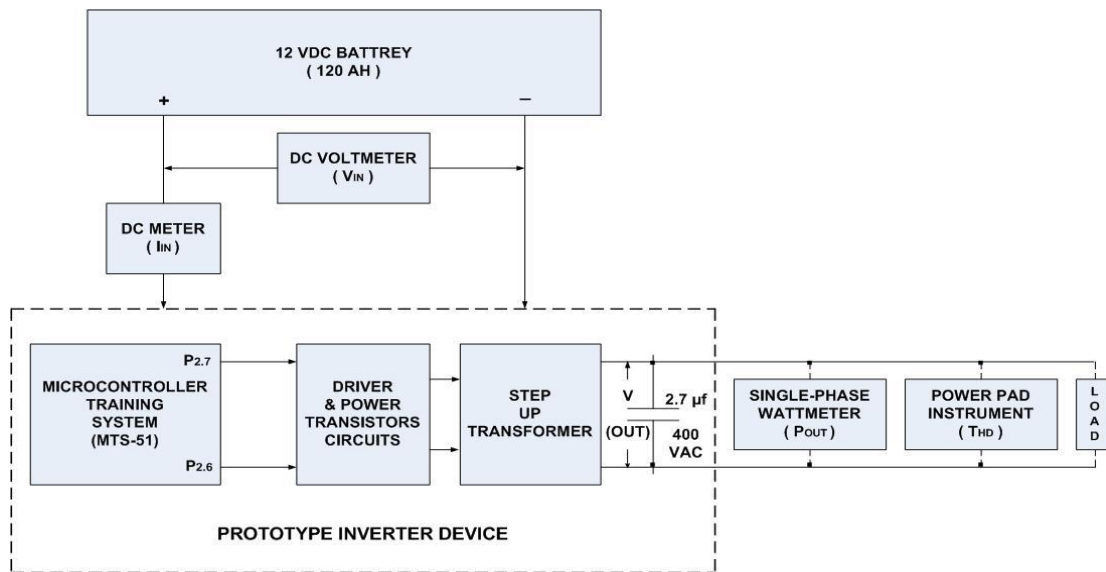

Fig. ( 10 ) : The SPWM Control signals (INV1& INV2) Setup

Many of non-inductive domestic devices are used to cover the inverter power range required for measurements. Table (3) indicates the measurement results taken for each case, while figure (11) shows the corresponding plot and histograms of the inverter parameters for different control signals. It is obvious from this figure that the SPWM(INV2) is not the best since with larger values of N, the amplitudes of LOH would be lower, but the amplitudes of some higher order harmonics would increase because switching losses of power transistors are increased. However, such higher order harmonics can be easily filtered out, and this agrees with that mentioned by Muhammad H.Rashid[2].

Inverter Parameters

| Control Signals | E.Loads (Watts) | Efficiency ( % ) |     |     |     |     | I (noload) (Ampere) | THD ( % ) |
|-----------------|-----------------|------------------|-----|-----|-----|-----|---------------------|-----------|
|                 |                 | 50               | 100 | 150 | 200 | 250 |                     |           |
| Square Wave     |                 | 31               | 52  | 57  | 61  | 62  | 7.0                 | 42.2      |
| INV1 (SPWM)     |                 | 41               | 61  | 65  | 67  | 68  | 3.5                 | 21.5      |
| INV2 (SPWM)     |                 | 36               | 56  | 58  | 60  | 60  | 4.6                 | 24.7      |

Table ( 3 ) : The Inverter Parameters for Different Control Signals

Finally figure (12) shows the laboratory experimental set.

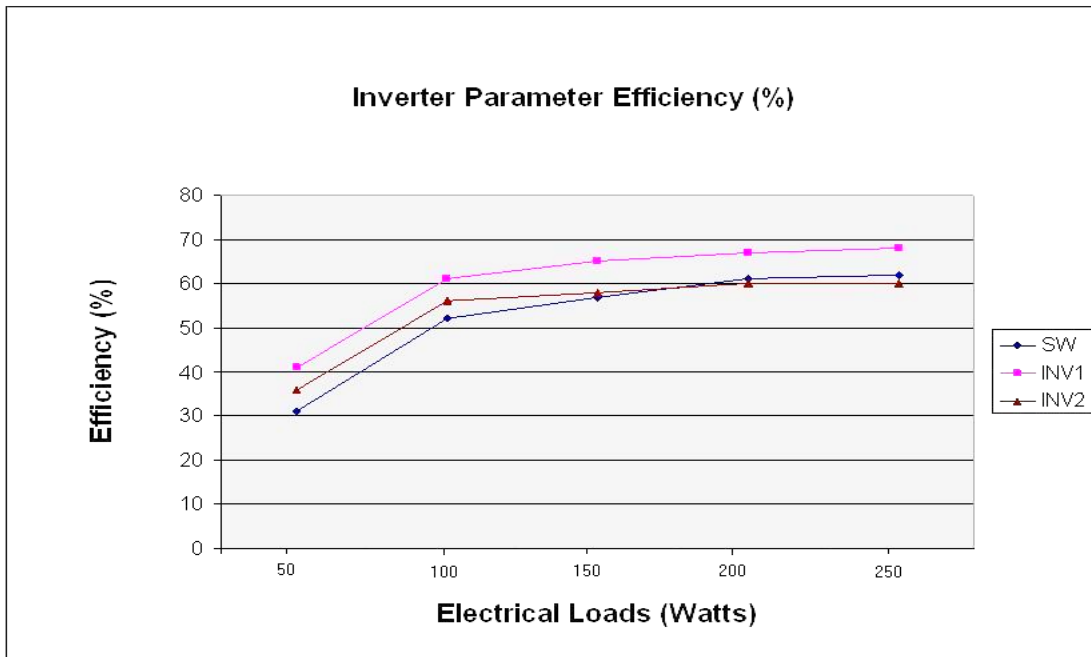

**a- Plot of Inverter Efficiency for different control signals**

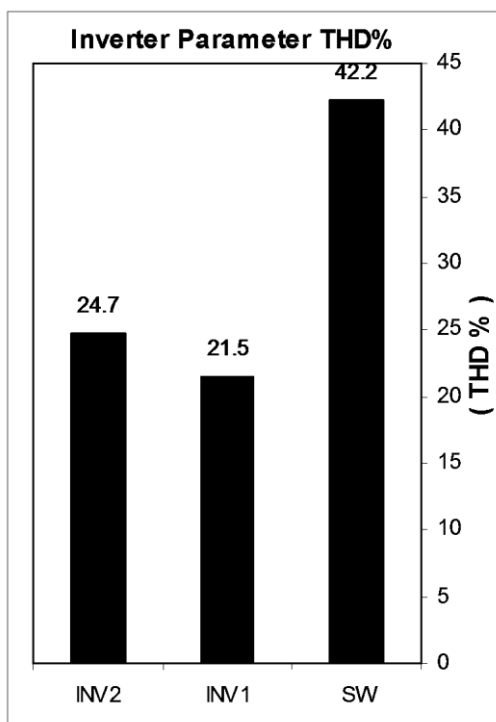

**b- Histogram of Inverter Parameter (THD%)**

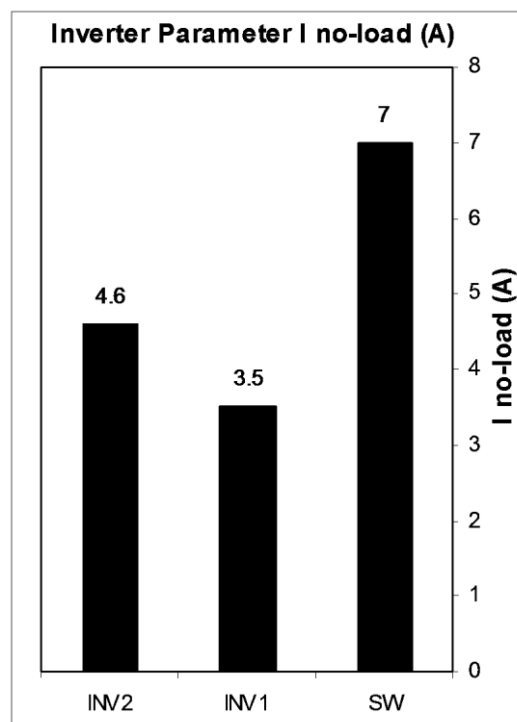

**c- Histogram of Inverter Parameter I no-load (A)**

**Fig. (11) : Plot and Histograms of Inverter Parameters for different control signals**



**a- Experimental Setup**

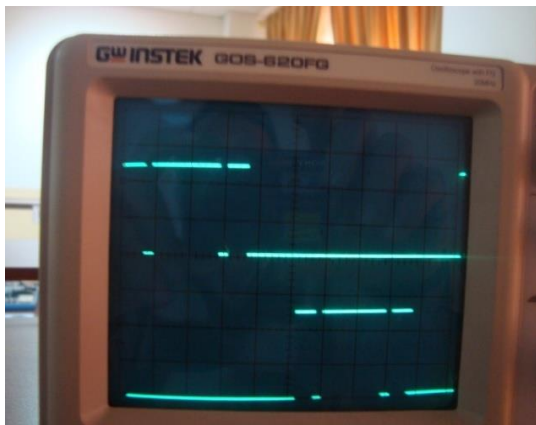

**b- Oscilloscope output for SPWM Control signal (N=3)**

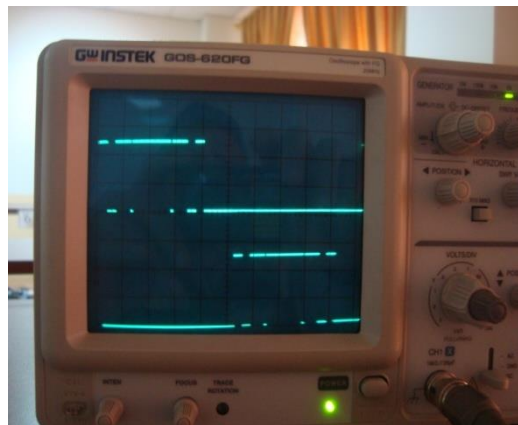

**c- Oscilloscope output for SPWM Control signal (N=5)**

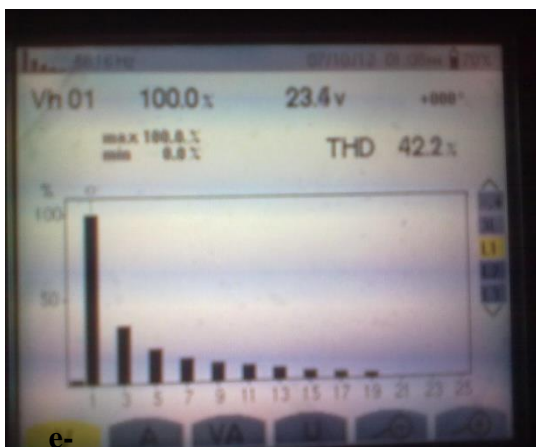

**d- THD measurement for SW control signal**

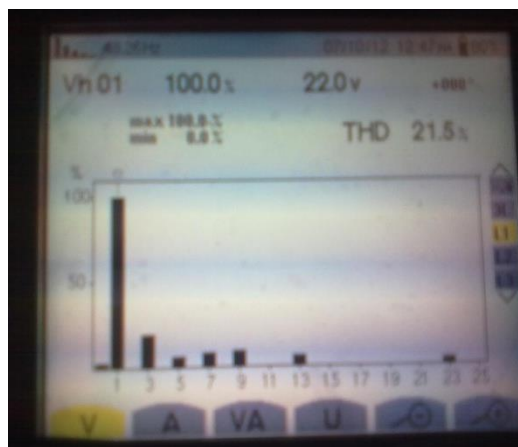

**e- THD measurement for INV1 control signal**

**Fig. (12) : Laboratory Experimental set photos**

**Conclusion**

The main objective of this research is to prove the validity of using the most common method of HE practically on a prototype inverter previously designed through the enhancement of its performance parameters. Our goal is the design and implementation of a simplified and reliable stand-alone microcontroller based solution system using Fourier analysis and MATLAB for generation of the required SPWM control signals.

The obtained experimental results are identical to that of MATLAB analysis done for the calculation of the switching angles needed for the elimination of the selected harmonics through the measurement of the basic inverter performance parameters (THD, I no-load &  $\gamma$ ) which are improved from (42.2,7A,62%) values for the (SW) control signal to the values (21.5,3.5A,68%) by applying HE method using the (INV1) control signal.

Finally, in this off-line method, a long time is spent for calculating the switching angles in relation to the modulation index and look-up tables are required. However this trouble can be solved by using the on-line method which is adopted in the current research [10].

### References

- [1] Ned Mohan, Tore M.Undeland, William P. Robbins " Power Electronics, Converters, Applications, and Design ", Dept. of Electrical Engineering, University of Minnesota, John Wiley & sons, Inc.,3<sup>rd</sup> Edition, 2003.
- [2] Muhammad H. Rashid " Power Electronics Circuits, Devices, and Applications ", Electrical and Computer Engineering, University of West Florida, Pearson Prentice Hall, 3<sup>rd</sup> Edition , 2004 (IVSL).
- [3] Erwin Kreyzzig " Advanced Engineering Mathematics Part -1- ", Professor of mathematics, Ohio State University, Columbus, Ohio, John Wiley & sons, Inc., 8<sup>th</sup> Edition, 1999.
- [4] Chiasson, J.N., Tolbert, L.M., McKenzie, K.J., and Du, Z.: " A complete solution to the harmonic elimination problem", IEEE Trans. Power Electro., 2004,19, 2, pp. 491-499.
- [5] Richard L. Burden, J.Douglas Faires " Numerical Analysis ", Youngstown State University, Wadsworth Group. Brooks / Cole, a division of Thomson Learning , Inc., 7<sup>th</sup> Edition , 2001.
- [6] I. Scott Mackenzie " The 8051 Microcontroller ", Prentice Hall, 3<sup>rd</sup> Edition, 1999.
- [7] MTS-51 Microcomputer Trainer, K&H MFG CO., LTD.5F, No.8, Sec.4 T2u-Chiang Rd., San Chung City 241, Taipei Hsien, Taiwan R.O.C.
- [8] M. Morris Mano " Computer System Architecture ", California State University, Los Angeles, Prentice-Hall International, 3<sup>rd</sup> Edition.
- [9] Musseb M.Jasim, Kamil G.Salih, Rasha E.Majed " Microcontroller Based Maximum Power Point Tracking For Photovoltaic Solar Panel ", Al-Rafidan Engineering Journal, vol.19, No.6, December 2011.
- [10] N.V. Nho, Dept. of Elect. Eng. , HCMUT, Vietnam, M.J. Youn , Dept. of Elect. Eng. , KAIST , Korea " A simple on-line SHE PWM With Extension to six Step Mode in two-level Inverters ", IEEE PEDS 2005.

**The work was carried out at the college of Engineering. University of Mosul**