

Design and Performance Evaluation of Lattice Daubechies Wavelet Filter Banks for Less Complex Cognitive Transceivers

Samar A. Yasser
samarammar@uomosul.edu.iq

Jassim M. Abdul-Jabbar
drjssm@uomosul.edu.iq

Qutaiba I. Ali
qutaibaali@uomosul.edu.iq

Computer Engineering Department, Collage of Engineering, University of Mosul

Received: 13/3/2020

Accepted: 6/6/2020

ABSTRACT

Wavelet Packet Based Multicarrier Modulation (WPMCM) system uses usually a prototype filter bank multicarrier. The Daubechies-D10 filter bank (D10FB) is the basic framework of multicarrier modulation (MCM) transceiver system. In this paper, Lattice structures of exact Daubechies-D10 wavelet filter are adopted to design a prototype filter bank realized for a proposed structure of WPMCM transceiver system. Magnitude and phase responses of the exact Daubechies-D10 LPF and the proposed structure are compared. They are nearly the same in the passband with improved roll-off characteristics of the magnitude response of the proposed. While from the results, it appears that the proposed WPMCM structure possess low speed of operation, less complexity and less power consumption. It is also noticed from SNR comparison, that the performance evaluation of the proposed WPMCM transceiver system is a moderate between other two previously issued structures.

Keywords:

OFDM; WPMCM Cognitive transceiver system; Lattice Daubechies-D10 Wavelet Filter; low complexity; BER.

<https://rengj.mosuljournals.com>

Email: alrafidain_engjournal1@uomosul.edu.iq

1. INTRODUCTION

In the last few decades, wireless applications have been expanding. This progress calls for further radio spectrum. However this radio spectrum is a limited resource and it becomes saturated. The spectrum was statically distributed under fixed spectrum access policy. National Telecommunication and Information Administration's (NTIA) allocates the spectrum frequency and demonstrates how the radio spectrum has been licensed and separated into number of bands where each band is specified to different services, such as mobile telephone, radio, television and others [1],[2].

Furthermore, it looks like that there is no much space to append any new services, except when some of the available licenses are suspended. Therefore in order to hold this issue and the discrepancy between spectrum rareness and spectrum underutilization, a smart wireless

communication system called cognitive radio (CR) is invented to allocate frequency spectrums and utilized optimally. Licensed users (LUs) in most wireless communication applications utilize frequency spectrums inefficiently and portions of frequency spectrums are not used. These portions is called spectrum holes. That's why CR has planned that these spectrum holes must be shared with unlicensed users (UUs) in the absence of LUs [3].

This paper is organized as follows: Section 1 explains an introduction to the issue to be solved in this paper. Theoretical bases of multicarrier systems such as OFDM and WPMCM are introduced in section 2 with the comparison of their performance and properties. Section 2 also provides the foundation of the traditional WPMCM system. Filter bank structures for analysis and synthesis to assure perfect reconstruction conditions, are also contained. This

section also shows the Lattice structure for wavelet filter bank be used to design the prototype filter. Section 3 gives a literature review for lattice structure.

In section 4, the proposed filter bank design model is adopted from the prototype lattice Daubechies-D10 wavelet filters. Section 5, shows many results and comparisons. The resulting magnitude and phase filter responses are included for the designed prototype filter and the deviation between responses of the exact and those of the proposed structures. A complexity comparison is also illustrated between the exact D10FB and the proposed filter bank. In addition, performance evaluation of three types of lattice wavelet filter bank studied according to BER vs. noise variance under several types of modulation schema for AWGN and Rayleigh fading channels are also considered. Finally, section 6 concludes this paper.

2. MULTICARRIER MODULATION SYSTEMS

Orthogonal frequency division multiplex OFDM based system was recommended to be the greatest candidate for CR transmission [4]. Recently wavelet packet filter bank system is investigated as a multicarrier modulation system (MCM). Such a system is called wavelet packet multicarrier modulation (WPMCM) and nominated as an attractive alternative multicarrier modulation technique for CR based systems. WPMCM has many interesting features such as, adaptability, flexibility, moderate complexity, side lobes suppression, spectrum efficiently, and has many advantages over the traditional Fast Fourier Transform FFT based OFDM systems [5].

The greater disadvantage of the OFDM is that the FFT process in OFDM decomposes the signals into sines and cosines, which cause high side lobes as a consequence of rectangular window application. Furthermore, the pulse shaping function used to modulate each subcarrier spreads to infinity in the frequency domain. By contrast, the wavelet packet transforms (WPTs) have extensive basis functions and can give power spectral density (PSD) with a higher degree of side lobes prevention. The long wavelet basis in WPMCM can allow for better frequency localization of subcarriers [6]. Regardless, the length of wavelet basis is much longer than the interval of a symbol causes some overlap in the time domain while preserving their orthogonality. Also, WPMCM progress robustness to carrier frequency offsets and timing offsets. Thus, WPT in WPMCM can progress a manner of functioning

against channel effects. Consequently, there is no need of cyclic prefix to attenuate the inter-symbol interference (ISI) which is a major disadvantage in the OFDM that causes bandwidth inefficiency, where the total bandwidth sacrifices by about 20% to 25% of it for cyclic prefix [7], [8].

Thus WPMCM gives great orthogonality between subcarriers and takes advantage of fixing up the imperfection in bandwidth wastage by having admirable spectral containment. Furthermore, WPMCM can be realized in a faster model and processed by less-complex computations, leading to some decrease in transmission power. In addition, WPMCM has the advantage of analysing signals in WPT by representing them in time-frequency domain rather than just the frequency domain as in FFT. That's why WPMCM has come out as admirable candidates for MCM in CR wireless communication systems [5],[9].

WPMCM transceiver system utilizes inverse wavelet packet transform (IWPT) at the transmitter side and WPT at the receiver side. At the receiver, the essential parts of WPMCM is a pair of quadrature mirror filters (QMFs), $\{h[n], g[n]\}$ half-band low and high pass analysis filter, respectively. On the other side, at the transmitter, it has a pair of quadrature mirror filters $\{p[n], q[n]\}$ half-band low and high pass synthesis filter, that are applied to create the wavelet packet carriers for modulation of data. The half-band low and high pass analysis filter with L length of each filter must satisfy the following condition [10]:

$$g[n] = (-1)^n h[L-n-1] \quad (1)$$

In addition to fulfil perfect reconstruction (PR), the pair of analysis and synthesis filter banks must be assure three specific conditions:

$$\begin{aligned} G[z] &= H[-z] \\ P[z] &= H[z] \\ \text{and} \\ Q[z] &= -H[-z] \end{aligned} \quad (2)$$

These conditions are due to presence the mirror image symmetry around the frequency $\omega = \pi/2$ in the middle of both QMF bank $H(e^{j\omega})$ and $G(e^{j\omega})$ as characterized in Fig. 1 [11].

Moreover realizing both orthonormality properties and PR, the analysis and synthesis filters must fulfil the following two conditions [11]:

$$\begin{aligned} H[-z]P[z] + G[z]Q[z] &= 0 \\ \text{and} \end{aligned} \quad (3)$$

$$H[z]P[z] + G[z]Q[z] = 2z^{-1} \quad (4)$$

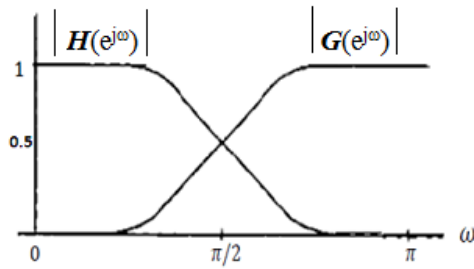

Fig. 1 Frequency responses of QM analysis filters, [11].

Fig. 2 explains the classical WPMCM structure of a transceiver with three-stage decomposition (8 channels) [12]. In this figure WPT is utilized in WPMCM. Therefore WPT uses multi-resolution technique by which different frequencies are analysed with different resolutions. Filter banks in WPT are used to divide the signal into a set of sub-band signals and change the resolution of that signal. So, using a multi-scale filter bank will analyse each sub-band signal with a resolution corresponds to its scale. That is the measuring of quantity of detail information in the signal. Accordingly, the up-sampling and down-sampling operations are employed to change the scale in the signal as seen in Fig. 2 [13], [14].

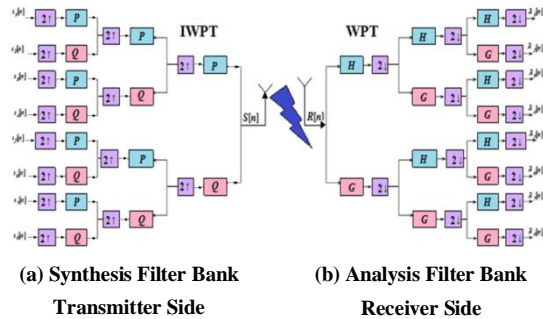

Fig. 2 WPMCM transceiver system for three-stage decomposition (8 channels) [12].

The IWPT is realised by WP synthesis filter bank which joins different parallel streams into a sole signal $S[n]$. After transmitting $S[n]$, WPT is implemented using WP analysis filter banks at the receiver. So the composite signal is separated into simpler compounds, as shown in Fig. 2.

In WPMCM transceiver system all modulation signals can be comprised of a sum of modulated wavelet packet coefficients $\zeta_l^p[n]$ weighted with complex data $a_{u,k}$, known as multicarrier symbols. The signal $S[n]$ can be expressed as follows [15]:

$$S[n] = \sum_u \sum_{k=0}^{N-1} a_{u,k} \zeta_{log_2(N)}^k(n - uN) \quad (5)$$

In Equation (5) every wavelet packet coefficient $\zeta_l^p[n]$ is computed as in the following two equations by convolving h and g filters with the wavelet packet coefficients from a prior level. This convolution process is performed again for all wavelet packets until attaining the desired resolution. This process is demonstrated clearly in wavelet packet analysis and is well explained in Fig. 2 (b) in Ref. [15].

$$\zeta_{l+1}^{2p}[n] = \sqrt{2} \sum_k h[k] \zeta_l^p[2n - k] \quad (6)$$

$$\zeta_{l+1}^{2p+1}[n] = \sqrt{2} \sum_k g[k] \zeta_l^p[2n - k] \quad (7)$$

With a reversed recurrent method, a wavelet packets synthesis filter bank can reconstruct the wavelet packets as follows:

$$\zeta_l^{2p}[n] = \sum_k h[k] \zeta_{l+1}^{2p}[2n - k] + \sum_k g[k] \zeta_{l+1}^{2p}[2n - k] \quad (8)$$

This reconstruction is called wavelet packet synthesis which illustrated in Fig. 2(a) [15]. The whole framework of the WPMCM transceiver system is described in Fig. 3.

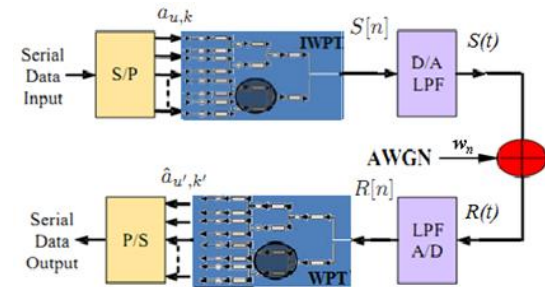

Fig. 3 WPMCM transceiver system framework.

When number of channels is increased, the complexity of whole system will be increased in an approximate exponential rate with base 2. This expensive issue must be resolved. In this paper, a new WPMCM-transceiver system structure is designed using a novel type of wavelet FIR filter bank called Lattice Daubechies Wavelet Filter Bank (LDWFB). The essential framework of such filter bank is realised in this paper with less-complexity.

Lattice structure will achieve less complexity goal due to the fact that it can be accomplished using two adders, two multipliers and one delay in each of analysis and synthesis trans-multiplexer lattice wavelet unit, where α_i is the value of the lattice coefficient at the i^{th} stage of trans-multiplexer lattice unit, as depicted in Fig. 4. Thus, lattice structure of wavelet filter banks introduces a new tool for constructing

trans-multiplexer model. In such model, a filter bank can be constructed from multiple stages of trans-multiplexer lattice wavelet units. Where parallel data channels should be multiplexed into one signal, transmitted and then reconstructed using synthesis and analysis lattice wavelet filter banks, respectively [16].

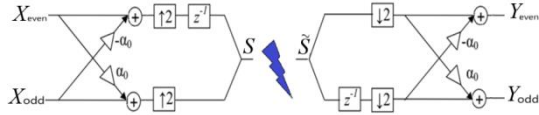

Fig. 4 First unit of synthesis and analysis trans-multiplexer lattice wavelet[16].

In this paper, the WPMCM system needs a filter bank multicarrier (FBMC) in model. Where FBMC is accomplished by orthogonal and QMF. The proposed filter banks is designed and realized as Lattice Daubechies-based transceivers. The Daubechies Wavelet filter banks (DFB) are used as the essential framework of such FIR filter banks and are adopted from Daubechies-D10 wavelet filter that are implemented in lattice structure filter bank, which will be used here in the design of a Daubechies wavelet multicarrier DWCM transceiver system. Where trans-multiplexer configuration for analysis filter bank in the receiver and synthesis filter bank in the transmitter to simulate a dual channel filter bank.

The most significant characteristic of DFBs is power symmetric. Power symmetric filter banks are allowed to be realized using lattice structures [17]. Where lattice structures are readily to implement [18]. Also in high degree parallelism the power symmetric filter banks can save together regularity and modularity, which causing high throughput. So the LDWFB are designed and realized in this paper which must have a real coefficients that satisfy the condition [19]:

$$|H(e^{jw})|^2 + |G(e^{jw})|^2 = 1 \quad \text{for all } w \quad (9)$$

In addition, the polyphase structure can be stand in by a lattice structure. Fig. 4 shows the construction of wavelet filter bank using lattice structure in trans-multiplexer model.

LDWFBs are designed to approximately satisfy the perfect reconstruction PR conditions. First design the filters' polyphase of the analysis filter Bank as below [20]:

$$H[z] = H_{even}[z^2] + z^{-1}H_{odd}[z^2] \quad (10)$$

$$G[z] = G_{even}[z^2] + z^{-1}G_{odd}[z^2] \quad (11)$$

Then the polyphase matrix A_p of the specified analysis filter Bank is as follow:

$$A_p[z] = \begin{bmatrix} H_{even}[z] & H_{odd}[z] \\ G_{even}[z] & G_{odd}[z] \end{bmatrix} \quad (12)$$

The transfer function in matrix form for the polyphase structure of LDWFB at the receiver side in WPMCM transceiver system will be:

$$S[z] = A_p[z]X[z] \quad (13)$$

$$\begin{bmatrix} S_{even} \\ S_{odd} \end{bmatrix} = \begin{bmatrix} H_{even}[z] & H_{odd}[z] \\ G_{even}[z] & G_{odd}[z] \end{bmatrix} \begin{bmatrix} X_{even} \\ X_{odd} \end{bmatrix} \quad (14)$$

where X_{even} and X_{odd} are used to denote the even and odd terms of input X , respectively. And S_{even} and S_{odd} are used to denote the even and odd terms of output S , respectively as depicted in Fig. 4.

3. LITERATURE REVIEW

Considerable researches has been published in this area and numerous lattice structures available in literature [11],[21]-[28].

In 1999, C. Gohet *al.*[21], used lattice structure to design two channel perfect reconstruction- quadrature mirror filter banks (PR-QMFB) by an efficient weighted least squares algorithm. The filter bank design problem was devised as a weighted least square problem with regards to the lattice coefficients. The weighted minimax lattice coefficients was optimized by iterative algorithm with only small number iterations. The lattice structure PR-QMFBs applied filters possessing stopband attenuation exceeding 100dB, with stopband ripple control.

In 2007, V. Herrero *et al.*[22], used folded lattice architecture where one filtering unit used to performs n-octaves levels of performing one-Dimensional (1-D) Daubechies DWT operations. This was accomplished by folding the outputs to the input n-1 times. The design was produced using the VIRTEX V100 hardware chip.

In 2013, J. M. Abdul-Jabbar and Z. Z. H. Altaei[11], designed and implemented discrete wavelet multi-tone (DWMT) transmission system using IIR wavelet filter banks. Bireciprocal lattice wave digital filters (BLWDFs) were implemented in an approximate linear phase designed of 11th order IIR wavelet filter bank for DWMT transmission systems. Again, in 2014, J. M. Abdul-Jabbar and R. W. Hamad[23], used lattice structure to design an efficient FIR filter bank. The lattice FIR filter bank coefficients were designed to simulate a 1st order Gaussian derivative. Lattice and polyphase FIR filter were implemented and designed for 5th order QRS-like filter banks for fuzzy classification of ECG signals. The QRS-like FIR filter bank is realized

to extract as much information as possible to classify different cardiac diseases in QRS wave.

In 2015, also J. M. Abdul-Jabbar, and O. N.Saadi[24], designed a linear phase IIR filter. The coefficients of the designed filter were fulfilled by simulating the FIR response of Ref.[23]. A least square method solution is used to minimize the error between transfer responses of their design and that of Ref.[23]. This minimization was simulated with a three intelligent computation algorithms. Bi-reciprocal lattice wave digital filters (WDFs) were implemented in a sufficient linear phase design of 5th order IIR wavelet filter bank for QRS complex detection.

In 2017, J. Lee and C. Ciou[25], designed and simulated a lattice structure of two-dimensional (2-D) two channel quincunx quadrature mirror filter QMF banks (QQMFBs), which utilized 2-D recursive symmetric half-plane (SHP) digital all-pass lattice (DAL) filters. This 2-D SHP QQMFB has a promising 2-D DC half-band property that permits nearby half of the 2-D recursive SHP DALF's coefficients to be zero. The simulation results evidence the efficiency of the designed 2-D recursive SHP DALFs in Lattice-Form as compared to 2-D SHP DALFs in the Direct-Form which designed in Ref. [26].

Again in 2017, A. Hamamoto, *et al.*[27], proposed multidimensional linear phase biorthogonal filter bank (MD LPBOFB) using a lattice structure with higher order feasible (HOF) building blocks. MD HOF building blocks fulfill both the linear phase and perfect reconstruction conditions. HOF structure is compared with a cascade of traditional order-1 structure in terms of the number of parameters, cost and coding gain. The HOF structure defeats the complexity and the cost for MD LPBOFBs designing, but sacrifices the coding gain.

In 2020, S. A. Al-Kishawi, *et al.*[28], designed a WPMCM system. The concept is employed to fulfill a design with near perfect reconstruction (NPR) and less-complex system realization. Bi-reciprocal lattice all-pass digital filter banks (BLAPDFBs) was implemented for NPR of 4th order IIR wavelet filter bank for WPMCM system. The foundation of IIR filter banks are Quadrature Mirror and half-band filter bank which based on the model established in Ref. [23].

4. THE PROPOSED LATTICE DAUBECHIES-D10 FILTER BANK (LD-10FB) MODEL

The LPF and HPF equations of the Daubechies-D10 wavelet filter bank are[29]:

$$H[z] = \sum_k h_k z^{-k} = h_0 + h_1 z^{-1} + h_2 z^{-2} + h_3 z^{-3} + h_4 z^{-4} + h_5 z^{-5} + h_6 z^{-6} + h_7 z^{-7} + h_8 z^{-8} + h_9 z^{-9} \tag{15}$$

$$G[z] = zH[-z^{-1}] = -h_9 + h_8 z^{-1} - h_7 z^{-2} + h_6 z^{-3} - h_5 z^{-4} + h_4 z^{-5} - h_3 z^{-6} + h_2 z^{-7} - h_1 z^{-8} + h_0 z^{-9} \tag{16}$$

where the Daubechies-D10 coefficients are [30]:

$$\begin{aligned} h_0 &\cong 0.22641898, h_1 \cong 0.85394354 \\ h_2 &\cong 1.02432694, h_3 \cong 0.19576696 \\ h_4 &\cong -0.34265671, h_5 \cong -0.04560113 \\ h_6 &\cong 0.10970265, h_7 \cong -0.00882680 \\ h_8 &\cong -0.01779187, h_9 \cong 4.71742793e-3 \end{aligned} \tag{17}$$

The magnitude and phase responses of $H[z]$ the Daubechies-D10 wavelet LPF are mapped in Fig. 5(a) & (b).

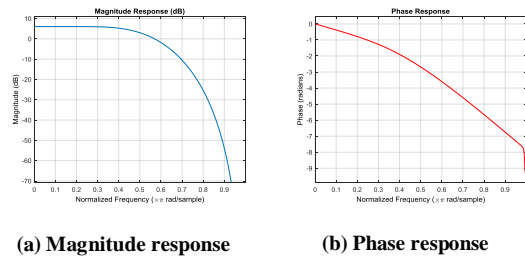

Fig. 5 The Frequency Response of the Daubechies-D10 wavelet LPF.

To calculate the corresponding polyphase matrix $A_P[z]$, $H[z]$ and $G[z]$ are separated into even and odd parts. So it will be:

$$A_P[z] = \begin{bmatrix} h_0 + h_2 z^{-1} + h_4 z^{-2} + h_6 z^{-3} + h_8 z^{-4} & h_1 + h_3 z^{-1} + h_5 z^{-2} + h_7 z^{-3} + h_9 z^{-4} \\ -h_9 - h_7 z^{-1} - h_5 z^{-2} - h_3 z^{-3} - h_1 z^{-4} & h_8 + h_6 z^{-1} + h_4 z^{-2} + h_2 z^{-3} + h_0 z^{-4} \end{bmatrix} \tag{18}$$

In consequence of Fig. 6, the polyphase matrix of lattice will be as follows:

$$A_L[z] = \begin{bmatrix} k_1 \beta & k_2 \beta \\ l_1 \beta & -l_2 \beta \end{bmatrix} \tag{19}$$

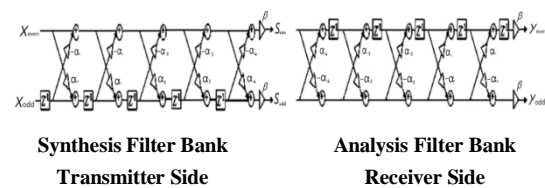

Fig. 6 The analysis and synthesis sides of the LD-10FB.

In Fig. 6, it can be observed the difference between the analysis and synthesis filter banks, the delay element is removed from the beginning of the lower branch in synthesis side to the end of the upper branch of the analysis side. Also it can be noticed the coefficient in the first analysis stage becomes the last synthesis one, in addition

the coefficient α_i stays in its arrange on the two sub branches but with reversed signs. This is as a result of the time reversal of the analysis side required to be accomplished in the synthesis side so that fulfil the perfect reconstruction condition.

By comparing equations (18) and (19) it conclude:

$$k_1 = 1 - \alpha_0\alpha_1z^{-1} - \alpha_0\alpha_2z^{-2} - \alpha_0\alpha_3z^{-3} - \alpha_0\alpha_4z^{-4} - \alpha_1\alpha_2z^{-1} - \alpha_1\alpha_3z^{-2} - \alpha_1\alpha_4z^{-3} - \alpha_2\alpha_3z^{-1} - \alpha_2\alpha_4z^{-2} - \alpha_3\alpha_4z^{-1} + \alpha_0\alpha_1\alpha_2\alpha_3z^{-2} + \alpha_0\alpha_1\alpha_2\alpha_4z^{-3} + \alpha_0\alpha_1\alpha_3\alpha_4z^{-2} + \alpha_0\alpha_2\alpha_3\alpha_4z^{-3} + \alpha_1\alpha_2\alpha_3\alpha_4z^{-2} \quad (20)$$

$$k_2 = -\alpha_0\alpha_1z^{-1} - \alpha_2z^{-2} - \alpha_3z^{-3} - \alpha_4z^{-4} + \alpha_0\alpha_1\alpha_2z^{-1} + \alpha_0\alpha_1\alpha_3z^{-2} + \alpha_0\alpha_1\alpha_4z^{-3} + \alpha_1\alpha_2\alpha_3z^{-2} + \alpha_1\alpha_2\alpha_4z^{-3} + \alpha_2\alpha_3\alpha_4z^{-3} - \alpha_0\alpha_1\alpha_2\alpha_3\alpha_4z^{-2} + \alpha_0\alpha_2\alpha_3z^{-1} + \alpha_0\alpha_2\alpha_4z^{-2} + \alpha_0\alpha_3\alpha_4z^{-1} + \alpha_1\alpha_3\alpha_4z^{-2} \quad (21)$$

$$l_1 = \alpha_0z^{-4} + \alpha_1z^{-3} + \alpha_2z^{-2} + \alpha_3z^{-1} + \alpha_4 - \alpha_0\alpha_1\alpha_2z^{-3} - \alpha_0\alpha_1\alpha_3z^{-2} - \alpha_0\alpha_1\alpha_4z^{-1} - \alpha_0\alpha_2\alpha_3z^{-3} - \alpha_0\alpha_2\alpha_4z^{-2} - \alpha_0\alpha_3\alpha_4z^{-3} - \alpha_1\alpha_2\alpha_3z^{-2} - \alpha_1\alpha_2\alpha_4z^{-1} - \alpha_1\alpha_3\alpha_4z^{-2} - \alpha_2\alpha_3\alpha_4z^{-1} + \alpha_0\alpha_1\alpha_2\alpha_3\alpha_4z^{-2} \quad (22)$$

$$l_2 = z^{-4} - \alpha_0\alpha_1z^{-3} - \alpha_0\alpha_2z^{-2} - \alpha_0\alpha_3z^{-1} - \alpha_0\alpha_4 - \alpha_1\alpha_2z^{-3} - \alpha_1\alpha_3z^{-2} - \alpha_1\alpha_4z^{-1} - \alpha_2\alpha_3z^{-3} - \alpha_2\alpha_4z^{-2} - \alpha_3\alpha_4z^{-3} + \alpha_0\alpha_1\alpha_2\alpha_3z^{-2} + \alpha_0\alpha_1\alpha_2\alpha_4z^{-1} + \alpha_0\alpha_1\alpha_3\alpha_4z^{-2} + \alpha_0\alpha_2\alpha_3\alpha_4z^{-1} + \alpha_1\alpha_2\alpha_3\alpha_4z^{-2} \quad (23)$$

By solving the four concluded equations, the values of lattice coefficients α_i and the value of scaling gain β will be as follows:

$$\alpha_0 = -2.62151901, \alpha_1 = 0.491024153 \\ \alpha_2 = -0.09215124, \alpha_3 = -0.0455492168 \\ \alpha_4 = -0.02083495, \beta = 0.22641898. \quad (24)$$

5. RESULTS AND COMPARISONS
5.1 RESPONSE COMPARISON

The resulting magnitude and phase responses of the designed Lattice Daubechies Wavelet LPF are plotted in Fig.7(a) & (b), respectively. It can be noticed that there is an improvement in the transition band between the original Daubechies-D10 filter and the proposed lattice Daubechies-D10 filter as is evident in Figs.

6(a) and 7(a). Also it is clear that Fig. 7(b) demonstrates an approximate linear phase processing, especially in passband region.

The passband deviations (maximum and average errors) between responses of the exact Daubechies-D10 LPF and the proposed structure Lattice Daubechies LPF are given in Table 1. It is clear that the two responses of exact and proposed are similar, with a slight difference.

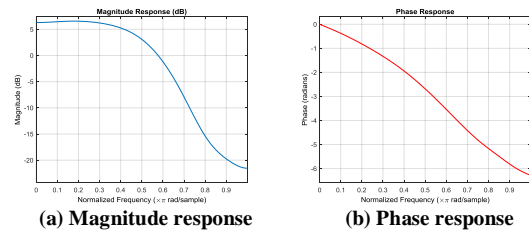

Fig. 7 The Frequency Response of the designed Lattice Daubechies LPF.

Table 1: Resulting errors in the frequency response.

Response	Max. Error	Average Error
Magnitude	0.1426103444489	0.0984621032193
Phase	3.2944287763970	1.5926780405617

5.2 COMPLEXITY COMPARISON

Table 2 show the complexity comparison between exact structure D10FB and the proposed lattice D10FB in either analysis side or synthesis side. This dominates both; the improvement in speed of the filtering operation, and the reduction in complexity of the proposed structure, and hence reducing the power consumption.

Table 2: ComplixityComperasion

	Exact D10FB	LatticeD10FB
Adder	18	10
Multiplier	20	12
Delay	18	5

5.3 PERFORMANCE EVALUATION OF WPMCM TRANSCEIVER SYSTEM

The objective of this subsection is to simulate the WPMCM transceiver system in order to evaluate the system performance based on the effect of various communication channels. Different modulation schemes are covered throughout simulation, and bit error rate (BER) is evaluated for the WPMCM transceiver system

under different channel noise models such as, AWGN and Fading Rayleigh channels.

In all simulations, the values of BER are compared according to noise variance for several MCM transceiver systems based on three different lattice structures. The first, MCM transceiver systems, is based on the structure of lattice FIR filter bank designed by Ref. [23], the second is the WPMCM transceiver system based on Bi-reciprocal lattice wave discrete wavelet IIR filter banks proposed by [28] and the third is based on the proposed structure LD-10FB. Also this simulation covers several types of modulation schema, such as BPSK, QPSK, 4FSK and M-QAM (for $M=4,8,16,64$) realized into two types of channels; AWGN channel and Rayleigh fading channel.

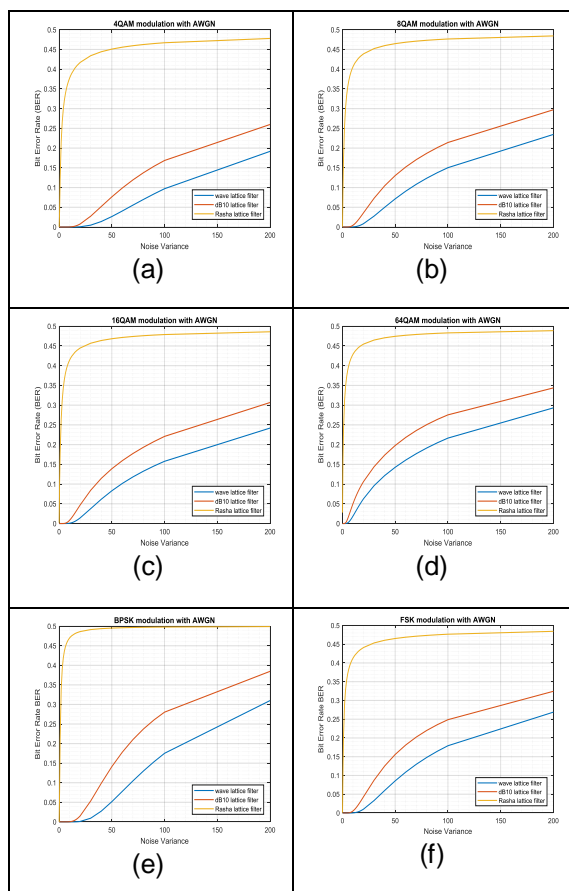

Fig. 8 BER vs. noise variance for AWGN channel.

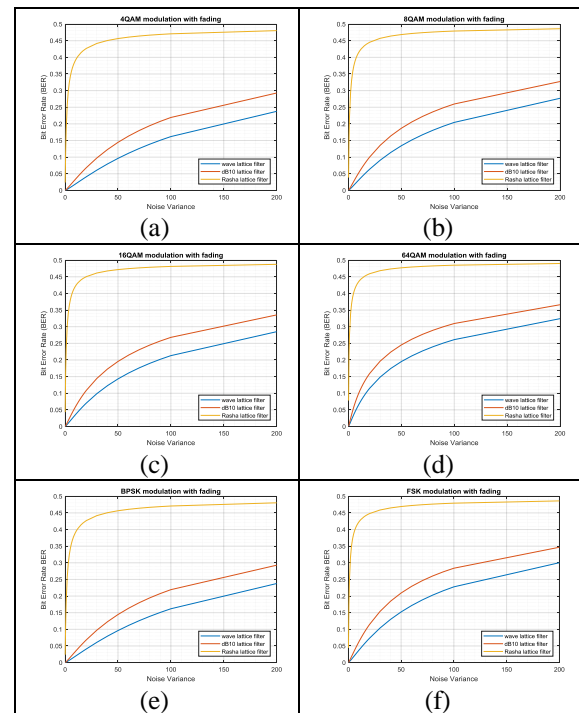

Fig. 9 BER vs. noise variance for Rayleigh fading channel.

Figures (8) and (9) show the performance evaluation of the three WPMCM transceiver systems in AWGN channel and Rayleigh fading channel, respectively for all adopted types of modulation.

Regarding Fig. 8 (a), (b), (c) and (d) it can be seen that as the modulation order increases BER increases too. Also Rayleigh fading channel achieved the same result, and it is shown in Figure 9 (a), (b), (c) and (d).

In addition Figs. 8 and 9 show that the BER for M-QAM, BPSK and FSK over a AWGN channel is less than that achieved in Rayleigh fading channel.

Finally, it can be concluded from all Figs. 8 and 9 that the best performance from the three WPMCM transceiver system is that based on Bi-reciprocal lattice wave discrete wavelet filter banks proposed by [28] and the system of worst performance is the exact lattice FIR filter bank designed by [23]. While the performance of the proposed structure LD-10FB is a moderate between the two.

All the results explained in this paper are established on computer simulation executed using MATLAB R2017b.

6. CONCLUSION

Lattice structures of exact Daubechies-D10 wavelet filter have been used to design prototype filter bank realized for WPMCM transceiver system. Magnitude and phase responses of the

exact Daubechies-D10 LPF and the proposed structure are nearly similar in the passband with improved roll-off characteristics of the magnitude response of the proposed. In addition, the proposed structure had possess low speed of operation, less complexity and less power consumption.

From BER comparisons, it had been noticed that the performance evaluation of the proposed WPMCM transceiver system moderate between other two previously issued structures.

ACKNOWLEDGEMENT

Authors wish to thank the administration of the College of Engineering and that of the Department of Computer Engineering-College of Engineering at the University of Mosul, Iraq; for their support in this study.

REFERENCES

- [1] J. Huang, H. Wang, and H. Liu, "A survey on cognitive radio networks," *International Conference on Mobile Wireless Middleware, Operating Systems, and Applications*, pp. 487–498, 2010.
- [2] R. Engelman, K. Abrokwah, and G. Dillon, "Federal Communications Commission Spectrum Policy Task Force," in *Report of the unlicensed Device and Experimental Licenses Working Group*, pp. 1–37, 2002.
- [3] S. Haykin, "Cognitive Radio: Brain-Empowered wireless communications," *IEEE Journal on Selected Areas in Communications*, vol. 23, no. 2, pp. 201–220, 2005.
- [4] A. M. Wyglinski, M. Nekovee, and Y. T. Hou, *Cognitive Radio Communications and Networks Principles and Practice*. 2010.
- [5] A. Jamin and P. Mähönen, "Wavelet packet modulation for wireless communications," *Wireless Communications and Mobile Computing*, vol. 5, no. 2, pp. 123–137, 2005.
- [6] H. Zhang and D. Yuan, "Research of DFT-OFDM and DWT-OFDM on Different Transmission Scenarios," in *International Conference on Information Technology & Applications (ICITA) proceeding*, pp. 31–33, 2004.
- [7] R. Parasad, *OFDM for Wireless Communication Systems*. Artech House, 2004.
- [8] R. van Nee and R. Prasad, *OFDM for Wireless Multimedia Communications*. Artech House, London, 2000.
- [9] M. K. Lakshmanan and H. Nikookar, "A review of wavelets for digital wireless communication," *Wireless Personal Communications*, vol. 37, no. 3–4, pp. 387–420, 2006.
- [10] H. Zhang, "WAVELET PACKET BASED MULTICARRIER CDMA WIRELESS COMMUNICATION SYSTEMS," Ph.D. Thesis, University of Cincinnati USA., 2004.
- [11] J. M. Abdul-jabbar and Z. Z. H. Al-taei, "Design and Implementation of DWMT Transmission Systems using IIR Wavelet Filter Banks," *International Journal of Computing and Digital Systems University of Bahrain Scientific Publishing Center*, vol. 2, no. 3, pp. 159–167, 2013.
- [12] M. K. Lakshmanan, D. D. Ariananda, and H. Nikookar, "A reconfigurable wavelet packet filter bank transceiver for spectral analysis and dynamic spectrum access," in *2011 IEEE International Symposium on Dynamic Spectrum Access Networks, DySPAN 2011*, 2011.
- [13] A. Mertin, *Signal Analysis Wavelets, Filter Banks, Time-Frequency Transforms and Applications*. John Wiley and Sons, 1999.
- [14] K. K. Shukla and A. K. Tiwari, "Filter Banks and DWT. In: Efficient Algorithms for Discrete Wavelet Transform," in *Springer Briefs in Computer Science*, Springer, London, pp. 21–36, 2013.
- [15] M. Tabaa, "A Novel Transceiver Architecture Based on Wavelet Packet Modulation for UWB-IR WSN Applications," *Wireless Sensor Network*, vol. 8, no. 9, pp. 191–209, 2016.
- [16] J. T. Oikkonen and H. Oikkonen, "Discrete Lattice Wavelet Transform," *IEEE Transactions on Circuits and Systems-II: Express Briefs*, vol. 54, no. 1, pp. 71–75, 2007.
- [17] P. P. Vaidyanathan, *Multirate Systems and Filter Banks*. Prentice Hall, 1993.
- [18] D. Sripathi, "Efficient Implementations of Discrete Wavelet Transforms Using Fpgas," Master Thesis, Electrical and Computer Engineering Department, Florida State University, 2003.
- [19] S. K. Mitra, *Digital Signal Processing A Computer-Based Approach*. 2011.
- [20] Z. R. Al-Omary and J. M. Abdul-Jabbar, "Design and FPGA Implementations of Four Orthogonal DWT Filter Banks Using Lattice Structures," *AL-Rafdain Engineering Journal (AREJ)*, vol. 19, no. 6, pp. 124–137, 2011.
- [21] C. K. Goh and Y. C. Lim, "An efficient algorithm to design weighted minimax perfect reconstruction quadrature mirror filter banks," *IEEE Transactions on Signal Processing*, vol. 47, no. 12, pp. 3303–3314, 1999.
- [22] V. Herrero, J. Cerdà, R. Gadea, M. Martínez, and A. Sebastià, "Implementation of 1-D Daubechies Wavelet Transform on FPGA," in *Online Symposium for Electronics Engineers (OSEE)*, vol. 0, pp. 1–5, 2007.
- [23] J. M. Abdul-Jabbar and R. Waleed Hamad, "Fuzzy Classification of ECG Signals Using A QRS-Like FIR Filter Bank with Lattice Structures," *AL-Rafdain Engineering Journal (AREJ)*, vol. 22, no. 2, pp. 1–12, 2014.
- [24] J. M. Abdul-Jabbar and O. Najeeb Saadi, "Genetic-Based IIR Filter Design for Efficient QRS Complex Detection using Neuro-Based Classifier," *AL-Rafdain Engineering Journal (AREJ)*, vol. 23, no. 4, pp. 172–182, 2015.
- [25] J. Lee and C. Ciou, "Design of Two-Channel

- Quincunx Quadrature Mirror Filter Banks Using Digital All-Pass Lattice Filters,” vol. 11, no. 5, pp. 535–541, 2017.
- [26] J. Lee and Y. Yang, “Two-Channel Quincunx QMF Banks Using Two-Dimensional Digital Allpass Filters,” *IEEE Transactions on Circuits and Systems I*, vol. 56, no. 12, pp. 2644–2654, 2009.
- [27] A. Hamamoto, M. Onuki, and Y. Tanaka, “Higher order feasible building blocks for lattice structure of multidimensional linear phase biorthogonal filter banks,” *Multidimensional Systems and Signal Processing*, vol. 28, no. 2, pp. 637–655, 2017.
- [28] S. A. Al-kishawi, J. M. Abdul-jabbar, and Q. I. Ali, “DESIGN AND REALIZATION OF LESS-COMPLEX WAVELET-BASED TRANSCIEVERS,” *Journal of Engineering Science and Technology (JESTEC)*, vol. 15, no. 2, pp. 1155–1166, 2020.
- [29] P. Getreuer, “Filter Coefficients to Popular Wavelets,” 2006.
- [30] “Daubechies wavelet,” *From Wikipedia, the free encyclopedia*. [Online]. Available: https://en.wikipedia.org/wiki/Daubechies_wavelet.

تصميم وتقييم أداء أجراء مرشحات Daubechies الموجية المتشابكة القليلة التعقيد لمرسلات ومستقبلات الاتصالات الإدراكية

قتيبة إبراهيم علي
qutaibaali@uomosul.edu.iq

جاسم محمد عبد الجبار
drjssm@uomosul.edu.iq

سمر عمار ياسر
samarammar@uomosul.edu.iq

جامعة الموصل - كلية الهندسة - قسم هندسة الحاسوب

الملخص

عادةً ما يستخدم نظام *WPMCM* نظامًا متعدد الناقلات لمرشح النموذج الأولي. إن مرشحات التصفية *Daubechies-D10 (D10FB)* هي الإطار الأساسي لنظام الإرسال والاستقبال متعدد التشكيل *MCM*. في هذا البحث، تم اعتماد هيكل متشابكة لمرشح الموجي *Daubechies-D10* لتصميم جرف مرشح أولي تم استخدامه للبنية المقترحة لنظام الإرسال والاستقبال *WPMCM*. تمت مقارنة استجابات السعة والطور لـ *Daubechies-D10 LPF* والهيكل المقترح. وهي متشابهة تقريبًا في نطاق التميرير مع خصائص انسيابية محسنة لاستجابة المقدار المقترحة. من النتائج، يبدو أن هيكل *WPMCM* المقترح يمتلك سرعة تشغيل منخفضة، أقل تعقيدًا واستهلاكًا أقل للطاقة. يلاحظ أيضًا من مقارنة *BER*، أن تقييم أداء نظام الإرسال والاستقبال *WPMCM* المقترح هو متوسط بين هيكليين سابقين تم إستراضهما.

الكلمات الدالة:

OFDM؛ نظام الإرسال والاستقبال الإدراكي *WPMCM*؛ المرشح الموجي *Daubechies-D10*؛ التعقيد القليل؛ *BER*.